

BT-8500

Quick Installation Guide

07-2020 / v1.0

Edimax Technology Co., Ltd.

No. 278, Xinhua 1st Rd., Neihu Dist., Taipei City, Taiwan

Email: support@edimax.com.tw

Edimax Technology Europe B.V.

Fijenhof 2, 5652 AE Eindhoven, The Netherlands

Email: support@edimax.nl

Edimax Computer Company

3444 De La Cruz Blvd., Santa Clara, CA 95054, USA

Email: support@edimax.com

Contents

I. Product Information & Safety Information	1
I-1. Package Contents	2
I-2. System Requirement	2
I-3. Hardware Interface	2
II. Hardware Installation	3
III. Driver Installation	4
IV. Adding Devices	6
V. Uninstall A Driver	9

I. Product Information & Safety Information

The Edimax BT-8500 dual mode (BR/EDR + LE) real Bluetooth 5.0 is a Nano USB adapter that supports data rate maximum 3 Mbps.

The BT-8500 is a portable ultra-small design USB adapter with USB 2.0, you can plug into any USB port and enjoy incredible high-speed Bluetooth 5.0.

Please install the unit with the safety restrictions outlined below:

- Do not place the USB adapter in or near hot/humid places, such as a kitchen or bathroom.
- There are no user-serviceable parts inside the USB adapter. If you experience problems with the USB adapter, please contact your dealer and ask for help.
- The USB adapter is an electrical device, if it becomes wet for any reason, stop using it immediately.

You can find all supporting documents from the link below or via QR Code:

<https://www.edimax.com/download>



(Once you've visited the Edimax official website, please enter model no. "BT-8500" into the search box to search for your product.)

Download

To select your product and find related download materials, enter the model number into the search box on the right side or follow the simple steps below:

*Feel free to contact us anytime if you need help or if you can't find your product.

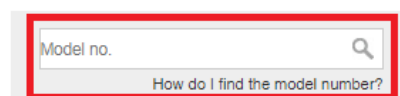

I-1. Package Contents

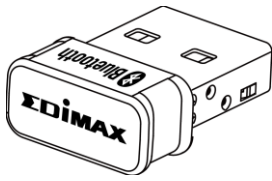

BT8500 USB Adapter



Quick Installation Guide

I-2. System Requirement

- Windows 8.1/10 32bit/64bit or above
- Linux: kernel 2.6.32~4.15, suggest 4.4 (after)
- 1 x USB 2.0 Type A

I-3. Hardware Interface

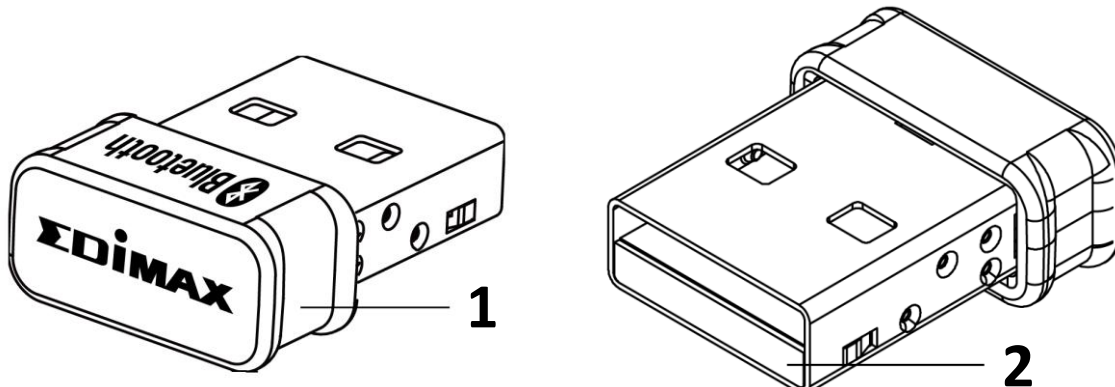

No.	Description
1	Case
2	USB 2.0 Type A

II. Hardware Installation

Please follow the steps below to install your Bluetooth USB adapter,

1. Turn on your PC.



If your PC or laptop has Bluetooth capability, please disable Bluetooth before using the Bluetooth USB adapter.

2. Insert the USB adapter into an available USB port of your computer.

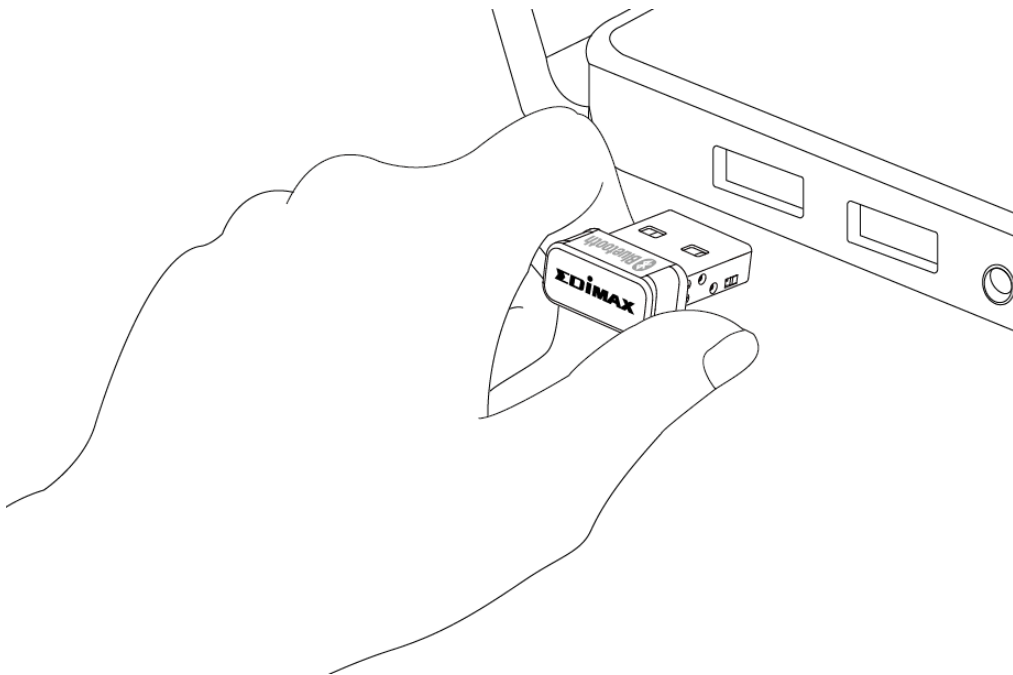

Never use force to insert the USB adapter.

III. Driver Installation

Please follow the steps below to install the driver,

1. Go to Edimax website (<https://www.edimax.com/edimax/global/>).
2. Enter model no. "BT-8500" into the search box to search for your product, and Go to Download, and download the driver.

Download

To select your product and find related download materials, enter the model number into the search box on the right side or follow the simple steps below:

*Feel free to contact us anytime if you need help or if you can't find your product.

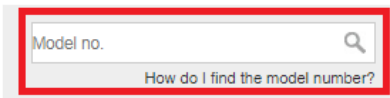

Model no.

[How do I find the model number?](#)

3. Open the folder and double click  setup.exe to install the driver.

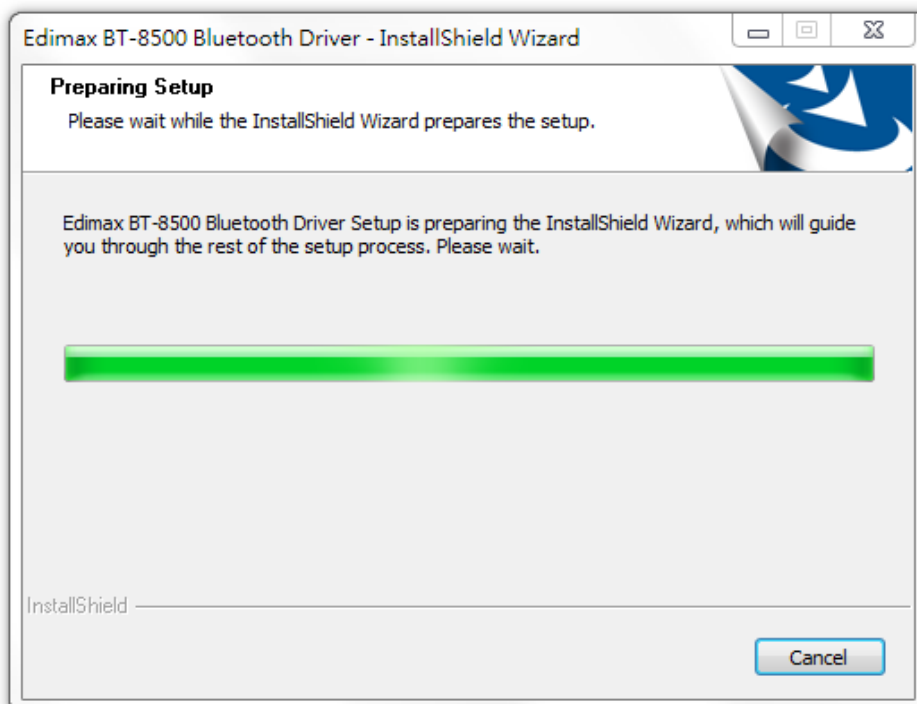

4. Click "Next" to continue and follow the instructions on-screen until installation is complete.

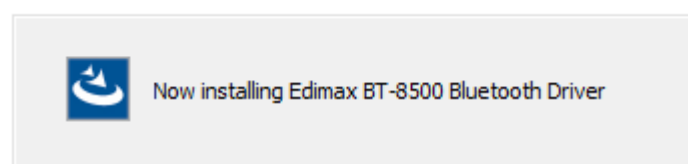
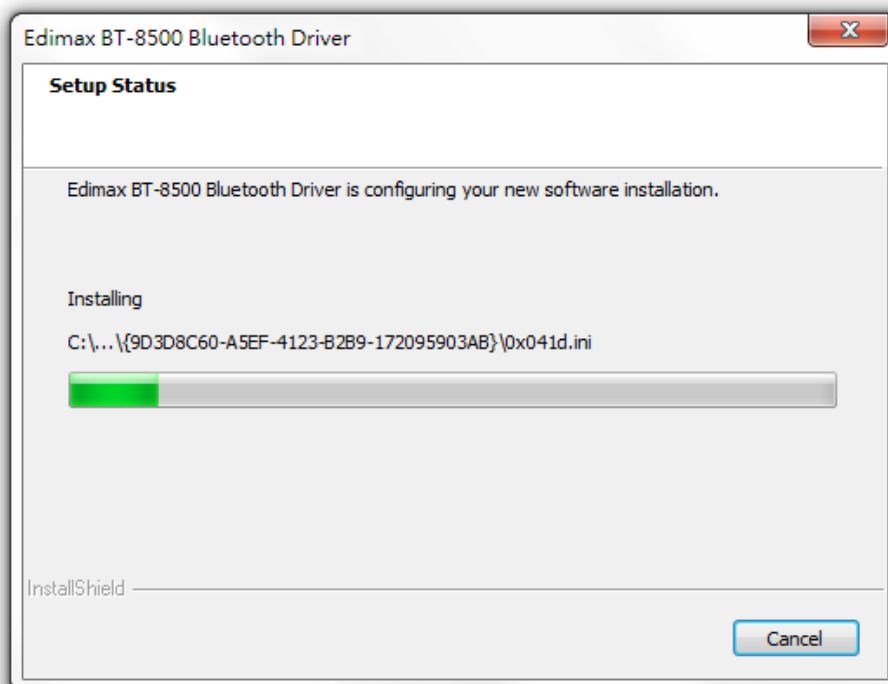
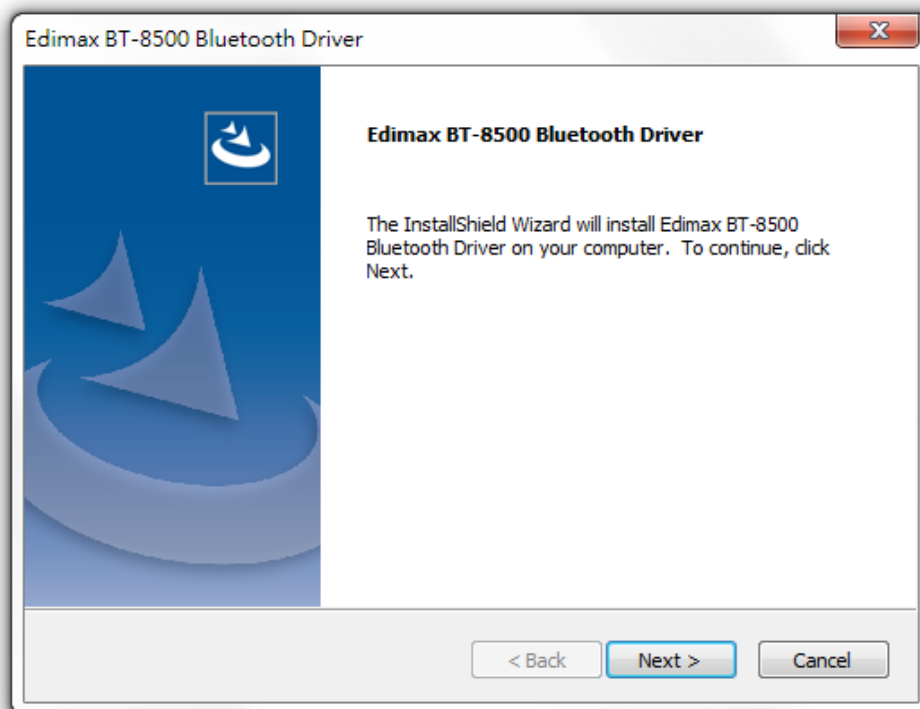

5. Select restart your computer now or later and click “Finish”.

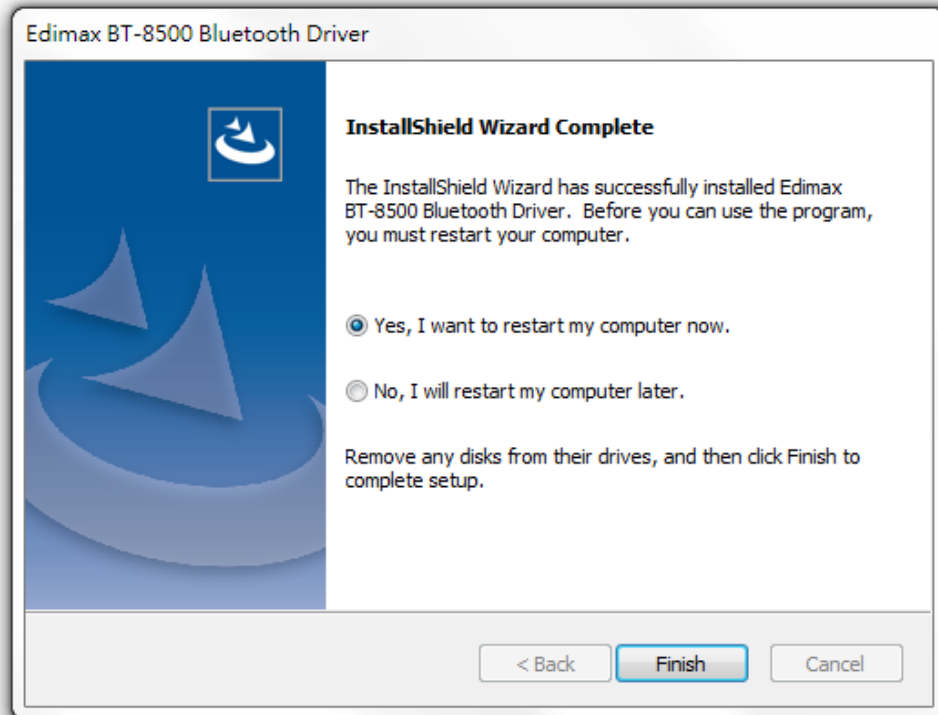

IV. Adding Devices

Please follow the steps below to add the Bluetooth devices,

1. Go to Windows Bluetooth settings by using the search bar, or by right clicking the Bluetooth icon in the task bar and choosing Add a Bluetooth Device.

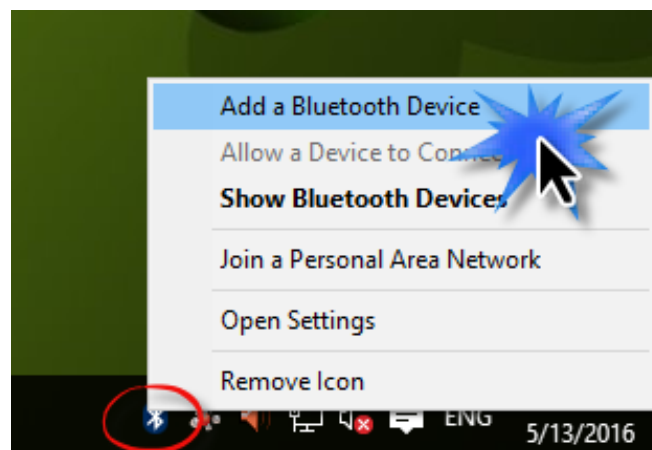

2. Select your Bluetooth device and click Pair and then confirm the passcode.

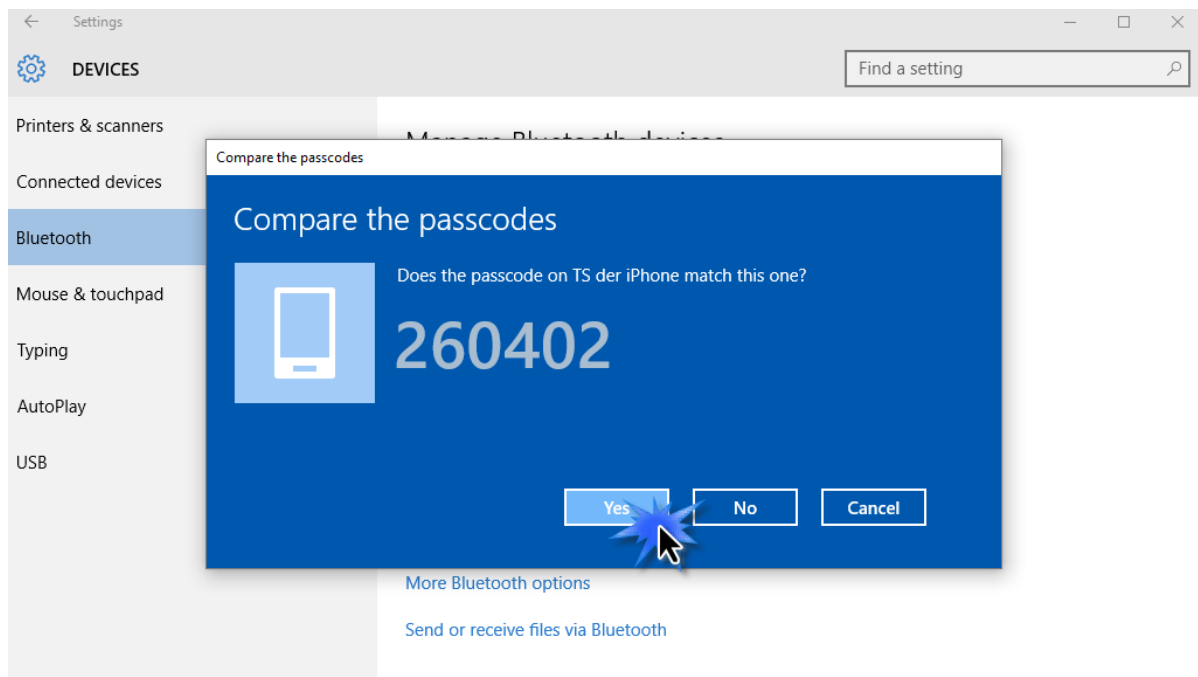
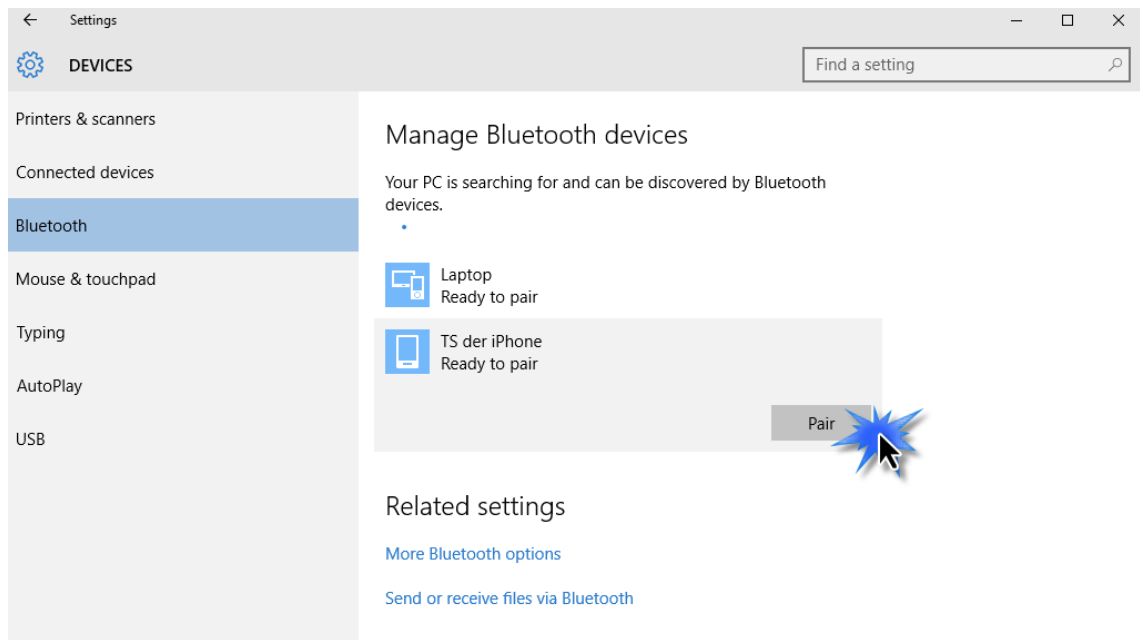

3. Your device is now ready to use when it shows “Connected”.

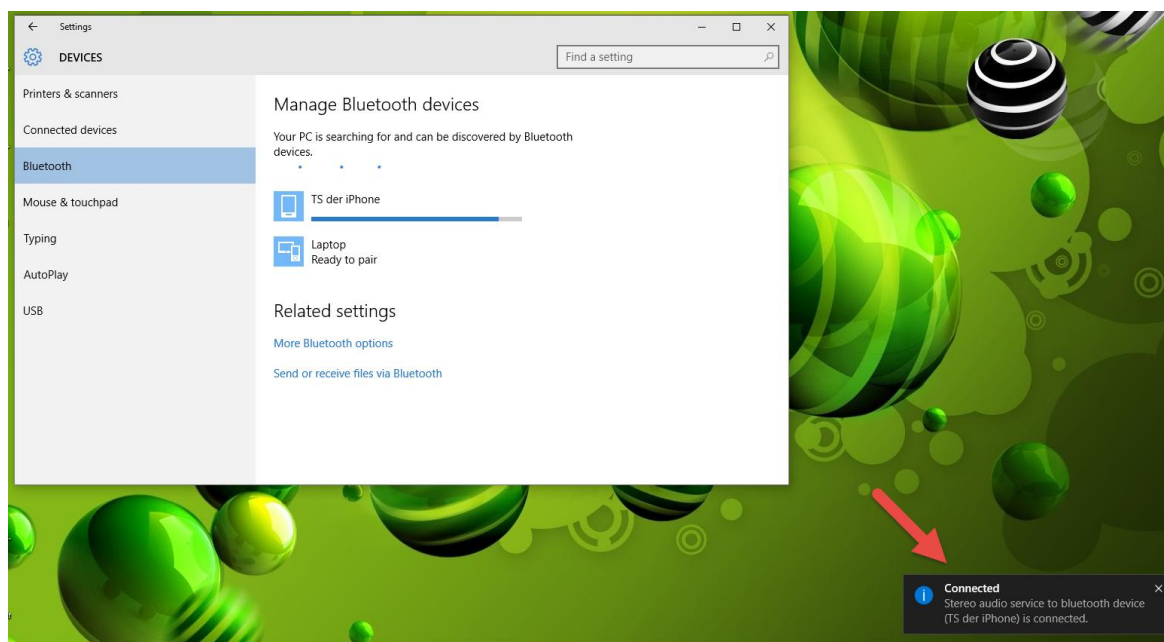
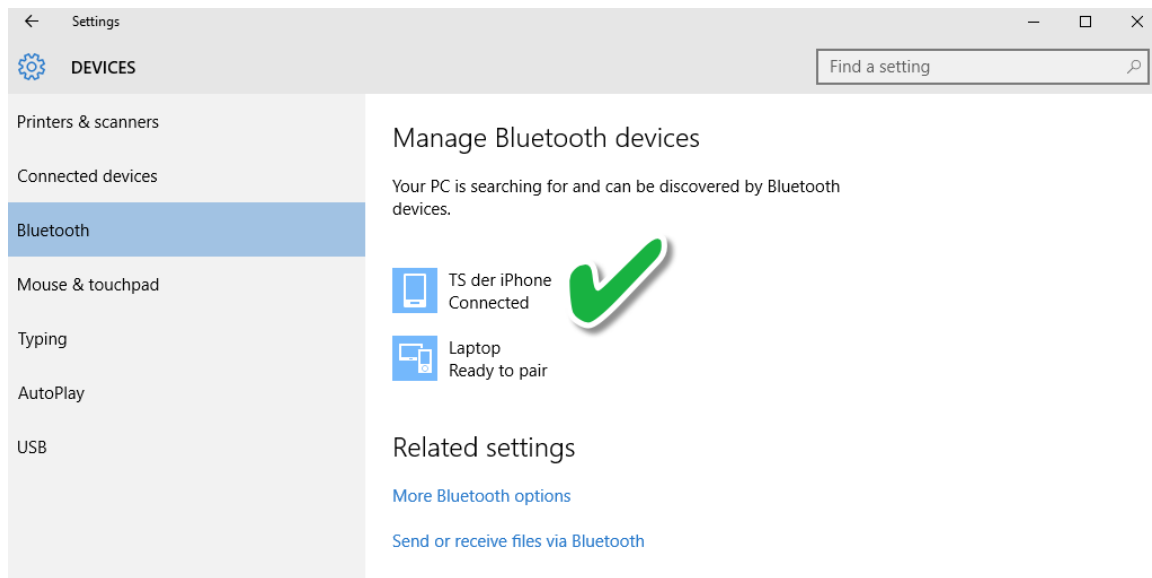

V. *Uninstall A Driver*

Please follow the steps below to uninstall a driver for your USB adapter,

1. Open Control Panel using the Start menu or Search function.

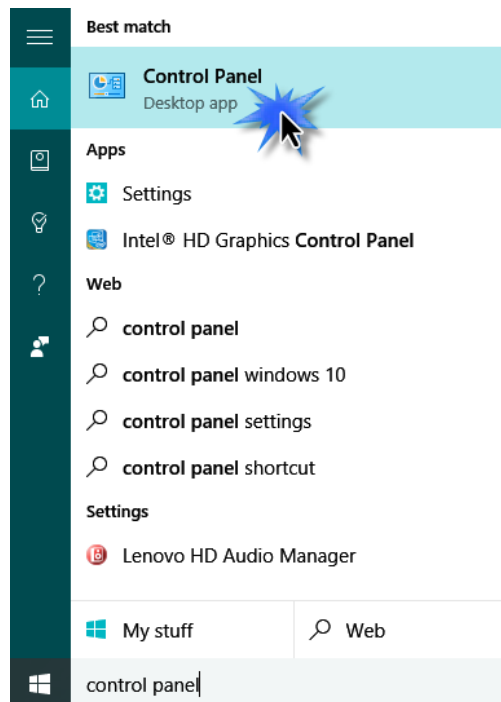

2. Select Uninstall a program under the Programs category.

Adjust your computer's settings

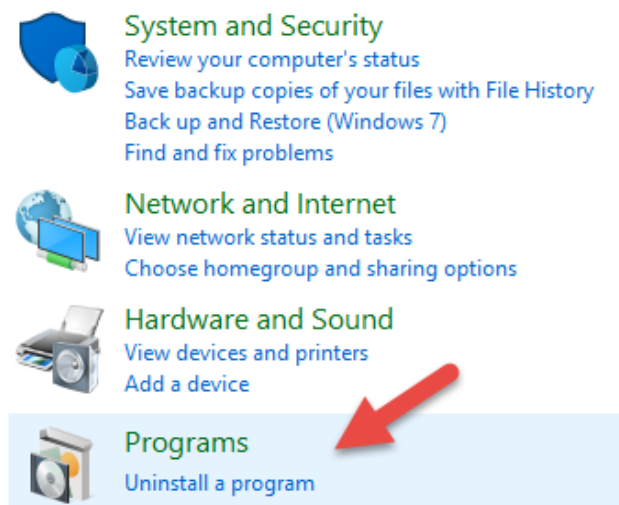

3. Select Edimax BT-8500 (or similar) and Edimax Bluetooth 5.0 (or similar) and click Uninstall.

Uninstall or change a program

To uninstall a program, select it from the list and then click Uninstall, Change or Repair.

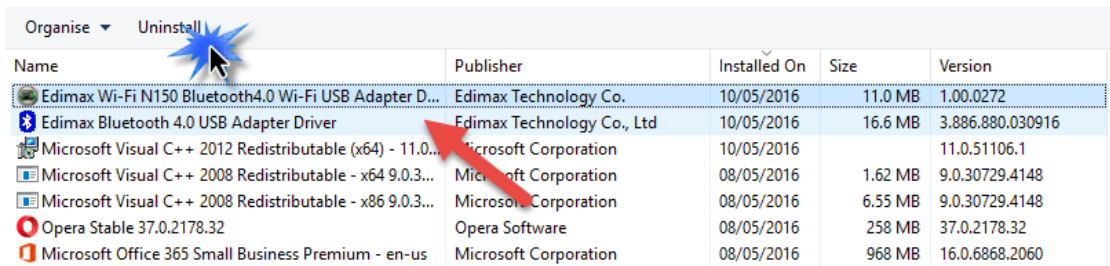

Name	Publisher	Installed On	Size	Version
Edimax Wi-Fi N150 Bluetooth4.0 Wi-Fi USB Adapter D...	Edimax Technology Co.	10/05/2016	11.0 MB	1.00.0272
Edimax Bluetooth 4.0 USB Adapter Driver	Edimax Technology Co., Ltd	10/05/2016	16.6 MB	3.886.880.030916
Microsoft Visual C++ 2012 Redistributable (x64) - 11.0...	Microsoft Corporation	10/05/2016		11.0.51106.1
Microsoft Visual C++ 2008 Redistributable - x64 9.0.3...	Microsoft Corporation	08/05/2016	1.62 MB	9.0.30729.4148
Microsoft Visual C++ 2008 Redistributable - x86 9.0.3...	Microsoft Corporation	08/05/2016	6.55 MB	9.0.30729.4148
Opera Stable 37.0.2178.32	Opera Software	08/05/2016	258 MB	37.0.2178.32
Microsoft Office 365 Small Business Premium - en-us	Microsoft Corporation	08/05/2016	968 MB	16.0.6868.2060

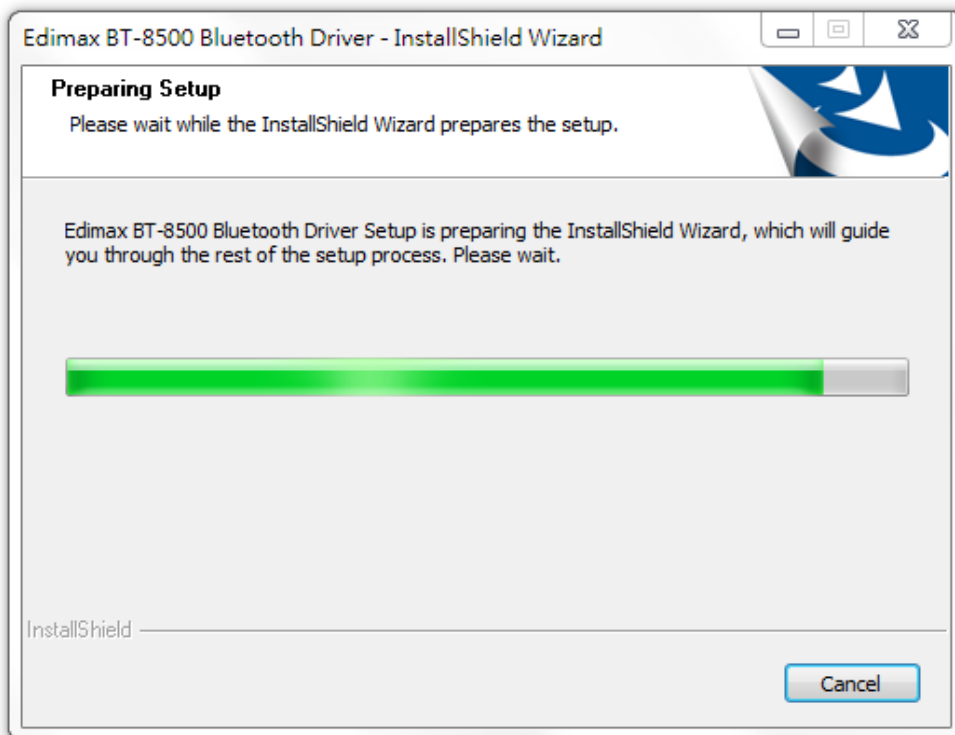

4. Click Yes to continue.



5. Select restart your computer now or later and click “Finish”.

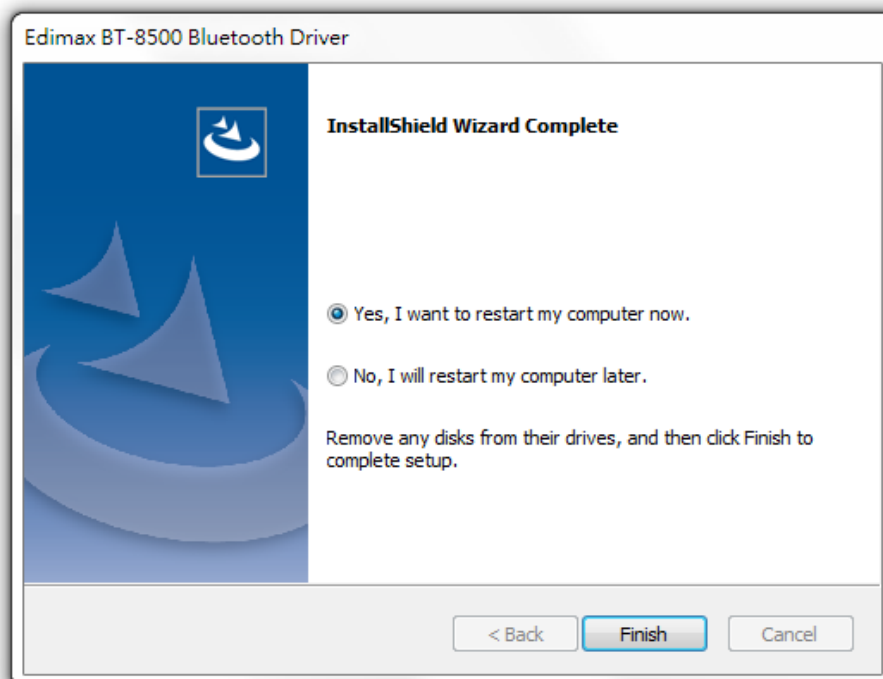

COPYRIGHT

Copyright © Edimax Technology Co., Ltd. all rights reserved. No part of this publication may be reproduced, transmitted, transcribed, stored in a retrieval system, or translated into any language or computer language, in any form or by any means, electronic, mechanical, magnetic, optical, chemical, manual or otherwise, without the prior written permission from Edimax Technology Co., Ltd.

Edimax Technology Co., Ltd. makes no representations or warranties, either expressed or implied, with respect to the contents hereof and specifically disclaims any warranties, merchantability, or fitness for any particular purpose. Any software described in this manual is sold or licensed as is. Should the programs prove defective following their purchase, the buyer (and not this company, its distributor, or its dealer) assumes the entire cost of all necessary servicing, repair, and any incidental or consequential damages resulting from any defect in the software. Edimax Technology Co., Ltd. reserves the right to revise this publication and to make changes from time to time in the contents hereof without the obligation to notify any person of such revision or changes.

The product you have purchased and the setup screen may appear slightly different from those shown in this QIG. The software and specifications are subject to change without notice. Please visit our website www.edimax.com for updates. All brand and product names mentioned in this manual are trademarks and/or registered trademarks of their respective holders.

Federal Communication Commission Interference Statement

This equipment has been tested and found to comply with the limits for a Class B digital device, pursuant to Part 15 of FCC Rules. These limits are designed to provide reasonable protection against harmful interference in a residential installation. This equipment generates, uses, and can radiate radio frequency energy and, if not installed and used in accordance with the instructions, may cause harmful interference to radio communications. However, there is no guarantee that interference will not occur in a particular installation. If this equipment does cause harmful interference to radio or television reception, which can be determined by turning the equipment off and on, the user is encouraged to try to correct the interference by one or more of the following measures:

1. Reorient or relocate the receiving antenna.
2. Increase the separation between the equipment and receiver.
3. Connect the equipment into an outlet on a circuit different from that to which the receiver is connected.
4. Consult the dealer or an experienced radio technician for help.

FCC Caution

This device and its antenna must not be co-located or operating in conjunction with any other antenna or transmitter. This device complies with Part 15 of the FCC Rules. Operation is subject to the following two conditions: (1) this device may not cause harmful interference, and (2) this device must accept any interference received, including interference that may cause undesired operation. Any changes or modifications not expressly approved by the party responsible for compliance could void the authority to operate equipment.

Federal Communications Commission (FCC) Radiation Exposure Statement

This equipment complies with FCC radiation exposure set forth for an uncontrolled environment.

Federal Communications Commission (FCC) RF Exposure Requirements

This equipment complies with FCC radiation exposure limits set forth for an uncontrolled environment. End user must follow the specific operating instructions for satisfying RF exposure compliance.

RED Compliance Statement

Compliance with 2014/53/EU Radio Equipment Directive (RED)

In accordance with Article 10.8(a) and 10.8(b) of the RED, the following table provides information on the frequency bands used and the maximum RF transmit power of the product for sale in the EU:

Frequency range (MHz)	Max. Transmit Power (dBm)
2412-2472	9.97

A simplified DoC shall be provided as follows: Article 10(9)

Hereby, Edimax Technology Co., Ltd. declares that the radio equipment type **Bluetooth 5.0 USB Adapter** is in compliance with Directive 2014/53/EU

The full text of the EU declaration of conformity is available at the following internet address: <http://www.edimax.com/edimax/global/>

Safety

This equipment is designed with the utmost care for the safety of those who install and use it. However, special attention must be paid to the dangers of electric shock and static electricity when working with electrical equipment. All guidelines of this and of the computer manufacture must therefore be allowed at all times to ensure the safe use of the equipment.

EU Countries Intended for Use

The ETSI version of this device is intended for home and office use in Austria, Belgium, Bulgaria, Cyprus, Czech, Denmark, Estonia, Finland, France, Germany, Greece, Hungary, Ireland, Italy, Latvia, Lithuania, Luxembourg, Malta, Netherlands, Poland, Portugal, Romania, Slovakia, Slovenia, Spain, Sweden, Turkey, and United Kingdom. The ETSI version of this device is also authorized for use in EFTA member states: Iceland, Liechtenstein, Norway, and Switzerland.

EU Countries Not Intended for Use

None

EU Declaration of Conformity

- English:** This equipment is in compliance with the essential requirements and other relevant provisions of Directive 2014/53/EU, 2014/35/EU.
- Français:** Cet équipement est conforme aux exigences essentielles et autres dispositions de la directive 2014/53/EU, 2014/35/EU.
- Čeština:** Toto zařízení je v souladu se základními požadavky a ostatními příslušnými ustanoveními směrnic 2014/53/EU, 2014/35/EU.
- Polski:** Urządzenie jest zgodne z ogólnymi wymaganiami oraz szczególnymi warunkami określonymi Dyrektywą UE 2014/53/EU, 2014/35/EU.
- Română:** Acest echipament este în conformitate cu cerințele esențiale și alte prevederi relevante ale Directivei 2014/53/UE, 2014/35/UE.
- Русский:** Это оборудование соответствует основным требованиям и положениям Директивы 2014/53/EU, 2014/35/EU.
- Magyar:** Ez a berendezés megfelel az alapvető követelményeknek és más vonatkozó irányelveknek (2014/53/EU, 2014/35/EU).
- Türkçe:** Bu cihaz 2014/53/EU, 2014/35/EU direktifleri zorunlu istekler ve diğer hükümlerle ile uyumludur.
- Українська:** Обладнання відповідає вимогам і умовам директиви 2014/53/EU, 2014/35/EU.
- Slovenčina:** Toto zariadenie spĺňa základné požiadavky a ďalšie príslušné ustanovenia smerníc 2014/53/EU, 2014/35/EU.
- Deutsch:** Dieses Gerät erfüllt die Voraussetzungen gemäß den Richtlinien 2014/53/EU, 2014/35/EU.
- Español:** El presente equipo cumple los requisitos esenciales de la Directiva 2014/53/EU, 2014/35/EU.
- Italiano:** Questo apparecchio è conforme ai requisiti essenziali e alle altre disposizioni applicabili della Direttiva 2014/53/EU, 2014/35/UE.
- Nederlands:** Dit apparaat voldoet aan de essentiële eisen en andere van toepassing zijnde bepalingen van richtlijn 2014/53/EU, 2014/35/EU.
- Português:** Este equipamento cumpre os requisitos essenciais da Directiva 2014/53/EU, 2014/35/EU.
- Norsk:** Dette utstyret er i samsvar med de viktigste kravene og andre relevante regler i Direktiv 2014/53/EU, 2014/35/EU.
- Svenska:** Denna utrustning är i överensstämmelse med de väsentliga kraven och övriga relevanta bestämmelser i direktiv 2014/53/EU, 2014/35/EU.
- Dansk:** Dette udstyr er i overensstemmelse med de væsentligste krav og andre relevante forordninger i direktiv 2014/53/EU, 2014/35/EU.
- suomen kieli:** Tämä laite täyttää direktiivien 2014/53/EU, 2014/35/EU. oleelliset vaatimukset ja muut asiaankuuluvat määräykset.

FOR USE IN 



WEEE Directive & Product Disposal



At the end of its serviceable life, this product should not be treated as household or general waste. It should be handed over to the applicable collection point for the recycling of electrical and electronic equipment, or returned to the supplier for disposal.

Declaration of Conformity

We, Edimax Technology Co., Ltd., declare under our sole responsibility, that the equipment described below complies with the requirements of the European Radio Equipment directives.

Equipment: Bluetooth 5.0 USB Adapter
Model No.: BT-8500

The following European standards for essential requirements have been followed:

Directives 2014/53/EU

Spectrum : EN 300 328 V2.2.2 (2019-07)

EMC : EN 301 489-1(Class B) V2.2.3 (2019-11)
EN 301 489-17 V3.2.2 (Draft) (2019-12)

EMF : EN 62479:2010

Safety (LVD) : IEC 62368-1:2014 (2nd Edition) and/or EN 62368-1:2014+A11:2017

Edimax Technology Europe B.V.
Fijenhof 2,
5652 AE Eindhoven,
The Netherlands

a company of :
Edimax Technology Co., Ltd.
No. 278, Xinhua 1st Rd.,
Neihu Dist., Taipei City,
Taiwan

Signature:

Printed Name: David Huang

Title: Director

Edimax Technology Europe B.V.



Date of Signature: July, 2020

Signature:

A handwritten signature in black ink, appearing to read 'Albert Chang', written over a horizontal line.

Printed Name:

Albert Chang

Title:

Director

Edimax Technology Co., Ltd.