

# CAP1200

## User Manual

11-2020 / v1.1

---

### **Edimax Technology Co., Ltd.**

No. 278, Xinhua 1st Rd., Neihu Dist., Taipei City, Taiwan

Email: [support@edimax.com.tw](mailto:support@edimax.com.tw)

---

### **Edimax Technology Europe B.V.**

Fijenhof 2, 5652 AE Eindhoven, The Netherlands

Email: [support@edimax.nl](mailto:support@edimax.nl)

---

### **Edimax Computer Company**

3444 De La Cruz Blvd., Santa Clara, CA 95054, USA

Email: [support@edimax.com](mailto:support@edimax.com)

# CONTENTS

<b>I. Product Information.....</b>	<b>1</b>
I-1. Package Contents .....	1
I-2. System Requirements.....	1
I-3. Hardware Overview .....	2
I-4. LED Status .....	3
I-5. Reset .....	4
I-6. Safety Information .....	5
<b>II. Quick Setup.....</b>	<b>6</b>
II-1. Initial Setup .....	6
II-2. Basic Settings .....	8
<b>III. Hardware Installation.....</b>	<b>12</b>
III-1. Connecting the access point to a router or PoE switch.....	12
III-2. Mounting the access point to a ceiling.....	13
III-3. T-Rail Mount .....	16
<b>IV. Browser Based Configuration Interface.....</b>	<b>18</b>
IV-1. Information .....	20
IV-1-1. System Information .....	20
IV-1-2. Wireless Clients.....	24
IV-1-3. Wireless Monitor .....	26
IV-1-4. Log.....	28
IV-2. Network Settings .....	30
IV-2-1. LAN-Side IP Address.....	30
IV-2-2. LAN Port.....	32
IV-2-3. VLAN .....	33
IV-3. Wireless Settings.....	34
IV-3-1. 2.4GHz 11bgn.....	34
IV-3-1-1. Basic .....	35
IV-3-1-2. Advanced .....	38
IV-3-1-3. Security .....	40
IV-3-1-3-1. No Authentication .....	41
IV-3-1-3-2. WEP.....	42
IV-3-1-3-3. IEEE802.1x/EAP.....	42
IV-3-1-3-4. WPA-PSK .....	42
IV-3-1-3-5. WPA-EAP.....	43
IV-3-1-3-6. Additional Authentication .....	43
IV-3-1-4. WDS .....	45

IV-3-2.	5GHz 11ac 11an .....	47
IV-3-2-1.	Basic .....	47
IV-3-2-2.	Advanced .....	50
IV-3-2-3.	Security .....	52
IV-3-2-4.	WDS .....	54
IV-3-3.	WPS.....	56
IV-3-4.	RADIUS.....	58
IV-3-4-1.	RADIUS Settings .....	59
IV-3-4-2.	Internal Server .....	61
IV-3-4-3.	RADIUS Accounts .....	63
IV-3-5.	MAC Filter .....	65
IV-3-6.	WMM.....	67
IV-4.	Management .....	69
IV-4-1.	Admin.....	69
IV-4-2.	Date and Time.....	72
IV-4-3.	Syslog Server .....	74
IV-4-4.	I'm Here .....	75
IV-5.	Advanced .....	76
IV-5-1.	LED Settings .....	76
IV-5-2.	Update Firmware .....	77
IV-5-3.	Save/Restore Settings.....	78
IV-5-4.	Factory Default .....	80
IV-5-5.	Reboot .....	81

## **V. Appendix .....82**

V-1.	Configuring your IP address.....	82
V-1-1.	Windows XP .....	83
V-1-2.	Windows Vista .....	85
V-1-3.	Windows 7 .....	87
V-1-4.	Windows 8 .....	91
V-1-5.	Mac .....	95
V-1-6.	Glossary.....	97

# I. Product Information

---

## I-1. Package Contents

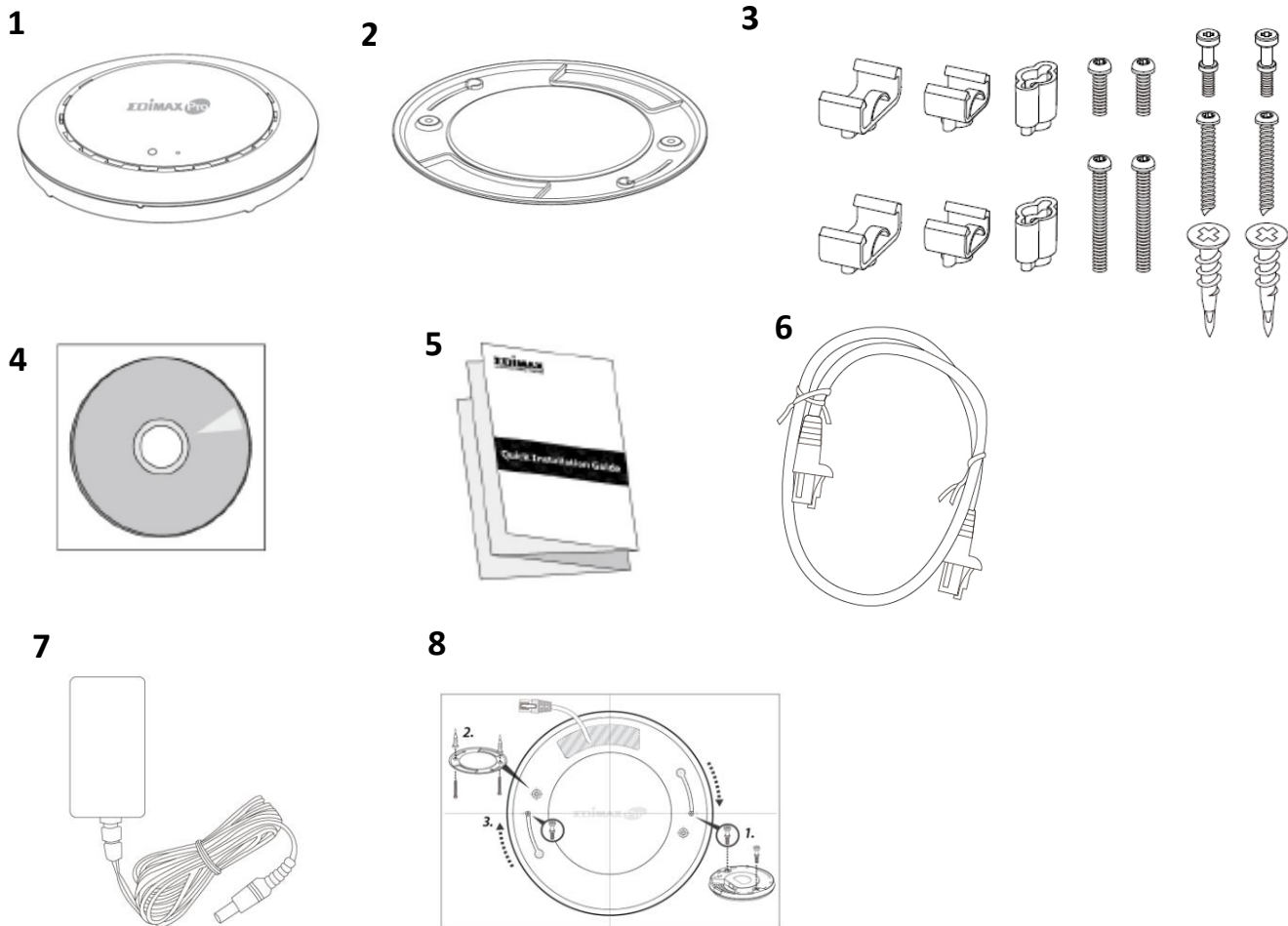

**1.** CAP1200 Access Point

**2.** Ceiling Mount Bracket

**3.** T-Rail Mounting Kit &  
Screws

**4.** CD

**5.** Quick Installation Guide

**6.** Ethernet Cable

**7.** Power Adapter

**8.** Ceiling Mount Screw Template

## I-2. System Requirements

- Existing cable/DSL modem & router
- Computer with web browser for access point configuration

### I-3. Hardware Overview

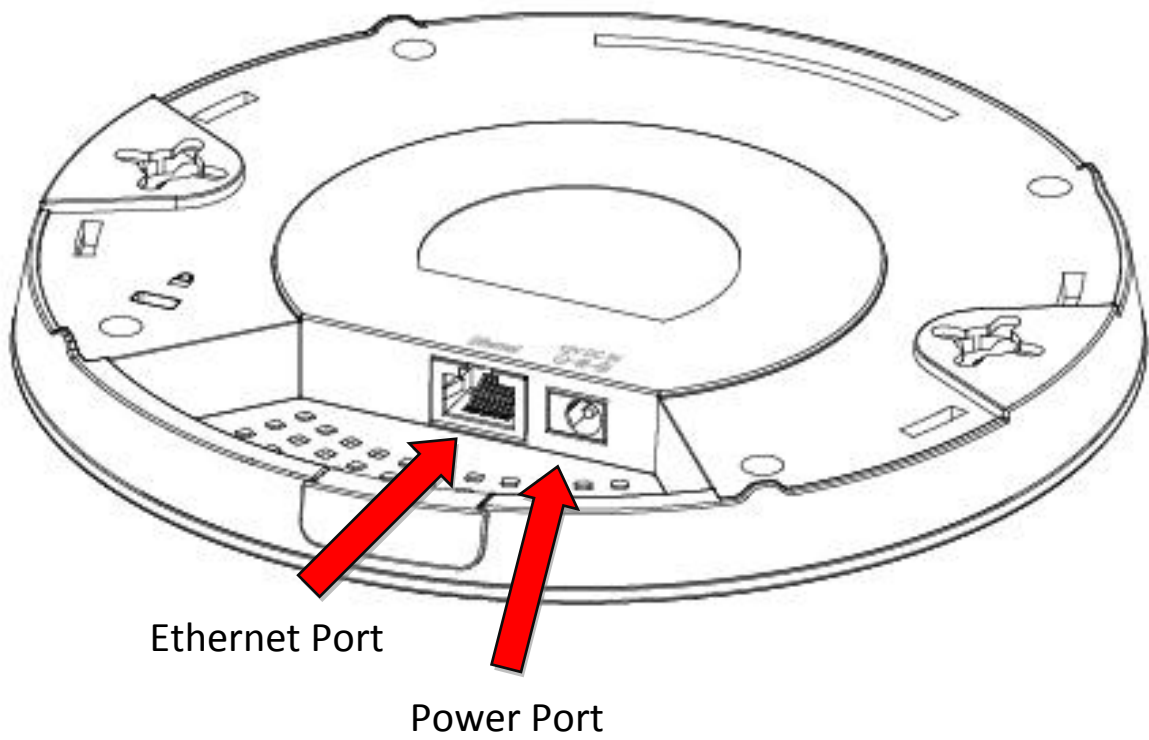

## I-4. LED Status

LED Color	LED Status	Description
Blue	On	The access point is on.
	Long Flashing	Upgrading firmware.
	Short Flashing	Resetting to factory defaults.
Amber	On	Starting up.
	Flashing	Error.
Off	Off	The access point is off.

## I-5. Reset

If you experience problems with your access point, you can reset the device back to its factory settings. This resets **all** settings back to default.

1. Press and hold the reset button on the access point for at least 10 seconds then release the button.



*You may need to use a pin or similar sharp object to push the reset button.*

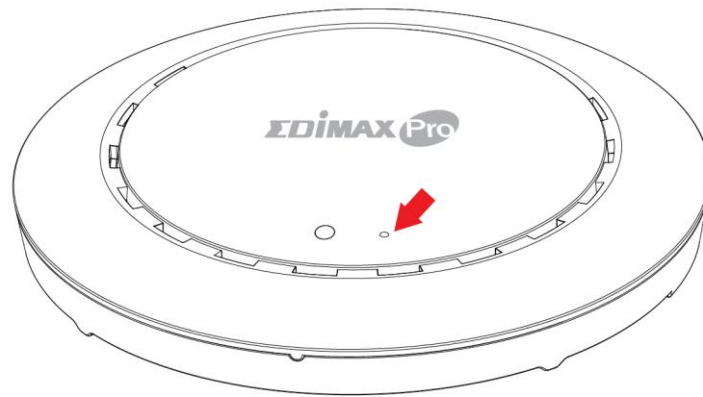

2. Wait for the access point to restart. The access point is ready for setup when the LED is **blue**.

## **I-6. Safety Information**

In order to ensure the safe operation of the device and its users, please read and act in accordance with the following safety instructions.

1. The access point is designed for indoor use only; do not place the access point outdoors.
2. Do not place the access point in or near hot/humid places, such as a kitchen or bathroom.
3. Do not pull any connected cable with force; carefully disconnect it from the access point.
4. Handle the access point with care. Accidental damage will void the warranty of the access point.
5. The device contains small parts which are a danger to small children under 3 years old. Please keep the access point out of reach of children.
6. Do not place the access point on paper, cloth, or other flammable materials. The access point may become hot during use.
7. There are no user-serviceable parts inside the access point. If you experience problems with the access point, please contact your dealer of purchase and ask for help.
8. The access point is an electrical device and as such, if it becomes wet for any reason, do not attempt to touch it without switching the power supply off. Contact an experienced electrical technician for further help.
9. If you smell burning or see smoke coming from the access point or power adapter, then disconnect the access point and power adapter immediately, as far as it is safely possible to do so. Call your dealer of purchase for help.



## II. Quick Setup

---

Your access point can be up and running in just a few minutes. This quick installation guide will help to set up your access point and configure its basic settings. Please follow the instructions in the chapters below:

### II-1. Initial Setup

1. Connect the access point to a computer via Ethernet cable.
2. Connect the power adapter to the access point's 12VDC port and plug the power adapter into a power supply using the included cable.

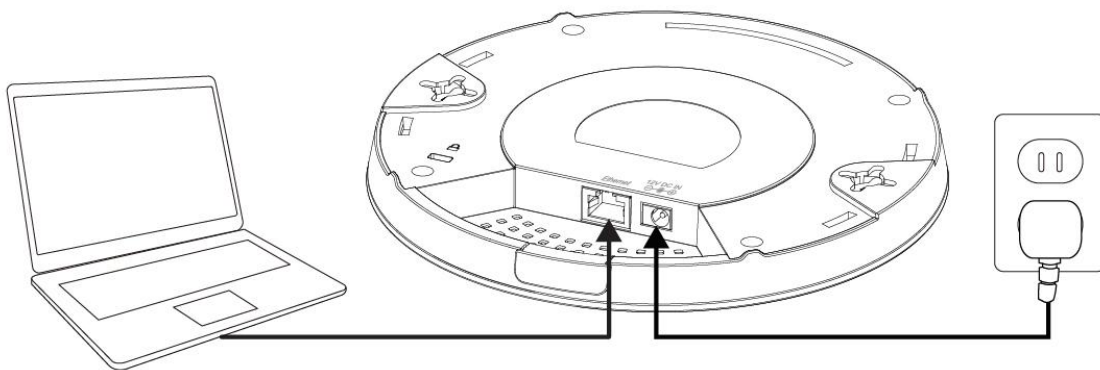

3. Please wait a moment for the access point to start up. The access point is ready when the LED is **blue**.
4. Set your computer's IP address to **192.168.2.x** where **x** is a number in the range **3 – 100**. If you are unsure how to do this, please refer to the user manual for more information.



***Please ensure there are no other active network connections on your computer (disconnect Wi-Fi connections and Ethernet cables).***

5. Enter the access point's default IP address **192.168.2.2** into the URL bar of a web browser.



6. You will be prompted for a username and password. Enter the default username “admin” and the default password “1234”.

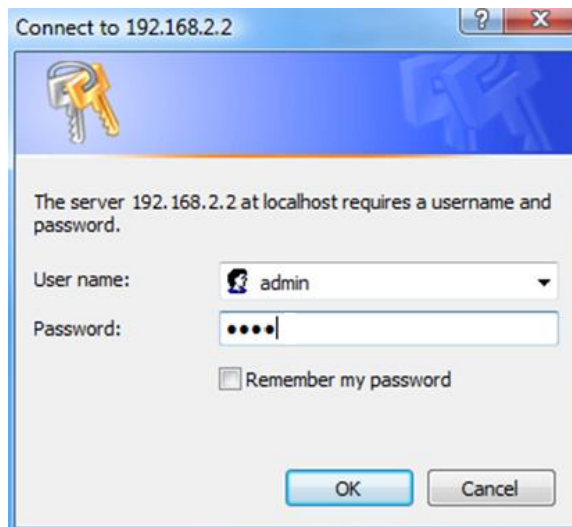

7. You will arrive the “System Information” screen shown below.

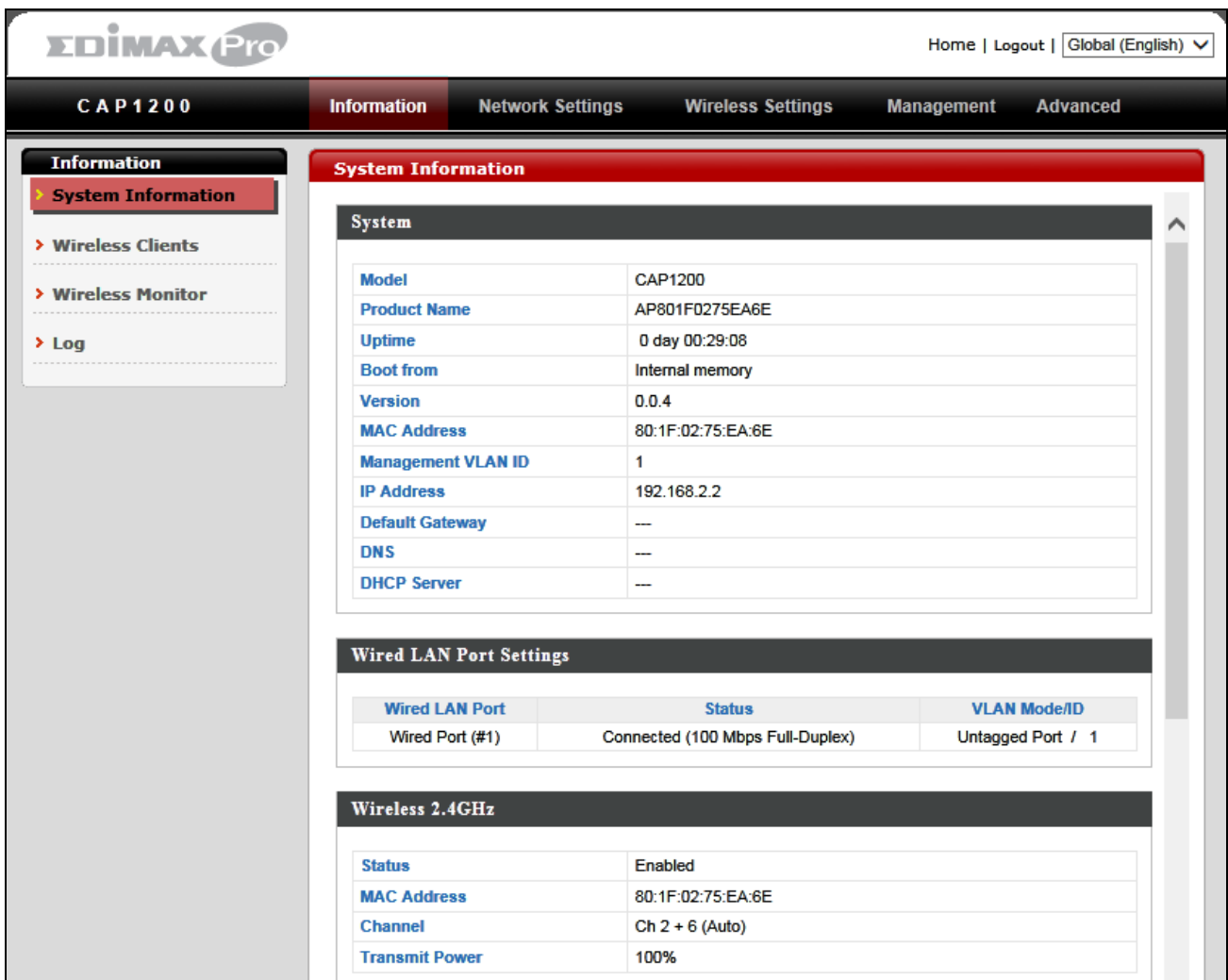

**EDIMAX Pro** Home | Logout | Global (English) ▾

CAP1200 Information Network Settings Wireless Settings Management Advanced

**Information**

- > System Information
- > Wireless Clients
- > Wireless Monitor
- > Log

**System Information**

**System**

Model	CAP1200
Product Name	AP801F0275EA6E
Uptime	0 day 00:29:08
Boot from	Internal memory
Version	0.0.4
MAC Address	80:1F:02:75:EA:6E
Management VLAN ID	1
IP Address	192.168.2.2
Default Gateway	--
DNS	--
DHCP Server	--

**Wired LAN Port Settings**

Wired LAN Port	Status	VLAN Mode/ID
Wired Port (#1)	Connected (100 Mbps Full-Duplex)	Untagged Port / 1

**Wireless 2.4GHz**

Status	Enabled
MAC Address	80:1F:02:75:EA:6E
Channel	Ch 2 + 6 (Auto)
Transmit Power	100%

8. Next, please follow the instructions below in **II-2. Basic Settings** to configure the access point's basic settings.

 ***For more advanced configurations, please refer to IV. Browser Based Configuration Interface.***

## II-2. Basic Settings

The instructions below will help you to configure the following basic settings of the access point:

- **LAN IP Address**
- **2.4GHz & 5GHz SSID & Security**
- **Administrator Name & Password**
- **Time & Date**

 ***It is recommended you configure these settings before using the access point.***

1. To change the access point's LAN IP address, go to **"Network Settings" > "LAN-side IP Address"** and you will see the screen below.

LAN-side IP Address	
IP Address Assignment	DHCP Client <input type="button" value="v"/>
IP Address	192.168.2.2
Subnet Mask	255.255.255.0
Default Gateway	From DHCP <input type="button" value="v"/> <input type="text"/>

DNS Servers	
Primary Address	From DHCP <input type="button" value="v"/> <input type="text"/>
Secondary Address	From DHCP <input type="button" value="v"/> <input type="text"/>

2. Enter the IP address settings you wish to use for your access point. You can use a dynamic (DHCP) or static IP address, depending on your network environment. Click "Apply" to save the changes and wait a few moments for the access point to reload.



**When you change your access point's IP address, you need to use the new IP address to access the browser based configuration interface instead of the default IP 192.168.2.2.**

- To change the SSID of your access point's 2.4GHz wireless network(s), go to **"Wireless Setting" > "2.4GHz 11bgn" > "Basic"**. Enter the new SSID for your 2.4GHz wireless network in the "SSID1" field and click "Apply".



**To utilize multiple 2.4GHz SSIDs, open the drop down menu labelled "Enable SSID number" and select how many SSIDs you require. Then enter a new SSID in the corresponding numbered fields below, before clicking "Apply".**

2.4GHz Basic Settings	
Wireless	<input checked="" type="radio"/> Enable <input type="radio"/> Disable
Band	11b/g/n
Enable SSID number	1
SSID1	CAP1200-CCDD10_G VLAN ID 1
Auto Channel	<input checked="" type="radio"/> Enable <input type="radio"/> Disable
Auto Channel Range	Ch 1 - 11
Auto Channel Interval	One day <input type="checkbox"/> Change channel even if clients are connected
Channel Bandwidth	Auto
BSS BasicRateSet	1,2,5.5,11 Mbps

- To configure the security of your access point's 2.4GHz wireless network(s), go to **"Wireless Setting" > "2.4GHz 11bgn" > "Security"**. Select an "Authentication Method" and enter a "Pre-shared Key" or "Encryption Key" depending on your choice, then click "Apply".



**If using multiple SSIDs, specify which SSID to configure using the "SSID" drop down menu.**

2.4GHz Wireless Security Settings	
SSID	CAP1200-CCDD10_G
Broadcast SSID	Enable
Wireless Client Isolation	Disable
Load Balancing	50 /50
Authentication Method	No Authentication
Additional Authentication	No additional authentication

5. Go to **“Wireless Setting” > “5GHz 11ac 11an”** and repeat steps **3 & 4** for the access point’s 5GHz wireless network.
6. To change the administrator name and password for the browser based configuration interface, go to **“Management” > “Admin”**.

Account to Manage This Device	
Administrator Name	admin
Administrator Password	••••• (4-32 Characters)
	••••• (Confirm)
<input type="button" value="Apply"/>	

7. Complete the **“Administrator Name”** and **“Administrator Password”** fields and click **“Apply”**.
8. To set the correct time for your access point, go to **“Management” > “Date and Time”**.

Date and Time Settings	
Local Time	2012 <input type="button" value="v"/> Year Jan <input type="button" value="v"/> Month 1 <input type="button" value="v"/> Day
	0 <input type="button" value="v"/> Hours 00 <input type="button" value="v"/> Minutes 00 <input type="button" value="v"/> Seconds
<input type="button" value="Acquire Current Time from Your PC"/>	
NTP Time Server	
Use NTP	<input type="checkbox"/> Enable
Server Name	<input type="text"/>
Update Interval	24 <input type="text"/> hours
Time Zone	
Time Zone	(GMT) Greenwich Mean Time: Dublin, Edinburgh, Lisbon, London <input type="button" value="v"/>

- 9.** Set the correct time and time zone for your access point using the drop down menus. The access point also supports NTP (Network Time Protocol) so alternatively you can enter the host name or IP address of a time server. Click “Apply” when you are finished.



***You can use the “Acquire Current Time from your PC” button if you wish to set the access point to the same time as your PC.***

- 10.** The basic settings of your access point are now configured. Please refer to **III. Hardware Installation** for guidance on connecting your access point to a router or PoE switch.

# III. Hardware Installation

---

## III-1. Connecting the access point to a router or PoE switch

**1.** If you need to, remove the cap from the underside of the access point. This creates extra space for your cables to pass through.

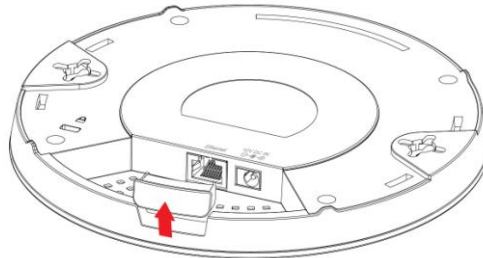

**2.** Connect a router or PoE switch to the access point's LAN port using an Ethernet cable.

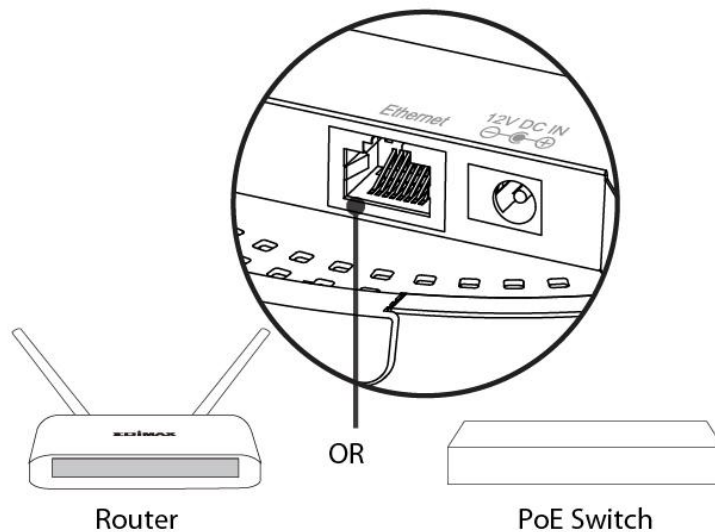

**3.** If you are using a router, then connect the power adapter to the access point's 12V DC port and plug the power adapter into a power supply.

 **Do not use the power adapter if you are using a PoE switch.**

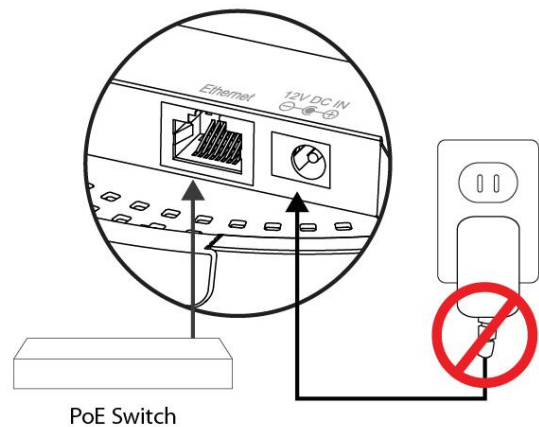

### **III-2. Mounting the access point to a ceiling**

To mount the access point to a ceiling, please follow the instructions below and refer to diagram **A & B**.

#### **For Wooden Ceilings (refer to diagram A):**

- 1.** Place the ceiling mount bracket to a ceiling in your desired location and insert screw **iii** through hole **i** (x 2) and tighten to fix the bracket in place.
- 2.** When the ceiling bracket is in place, insert screw **iv** into hole **v** (x 2) on the access point.
- 3.** Fix the access point to the ceiling bracket by inserting the attached screws **iv** into hole **vi** and twisting the access point.
- 4.** Lock the access point firmly into place when by twisting it to align screws **iv** with the grooves in the ceiling mount.

#### **For Other Ceilings (refer to diagram B):**

- 1.** Place the ceiling mount bracket to a ceiling in your desired location and Insert screw **ii** through hole **i** (x 2) and tighten to fix the bracket in place, as shown in **A**.
- 2.** Insert screw **iii** through hole **i** and into the rear of screw **ii** and tighten to provide additional strength.
- 3.** When the ceiling bracket is in place, insert screw **iv** into hole **v** (x 2) on the access point.
- 5.** Fix the access point to the ceiling bracket by inserting the attached screws **iv** into hole **vi** and twisting the access point.
- 6.** Lock the access point firmly into place by twisting it to align screws **iv** with the grooves in the ceiling mount.



**A**

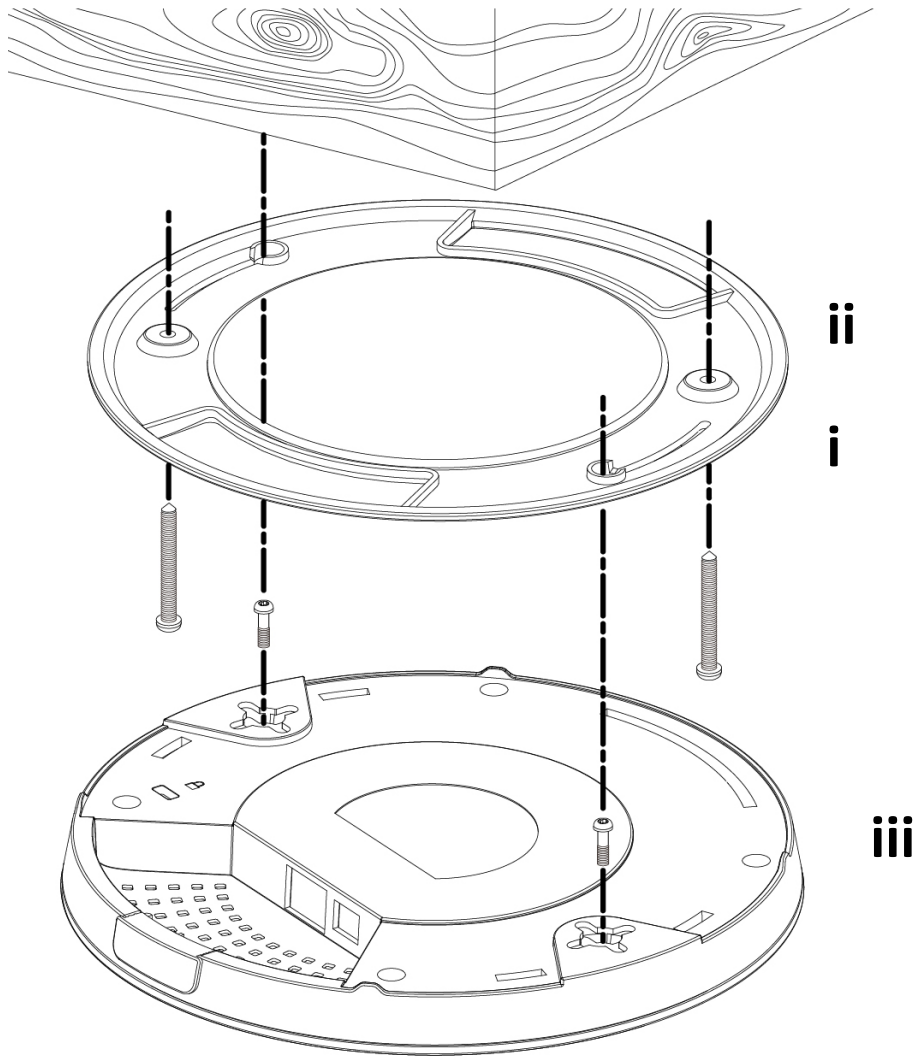

**B**

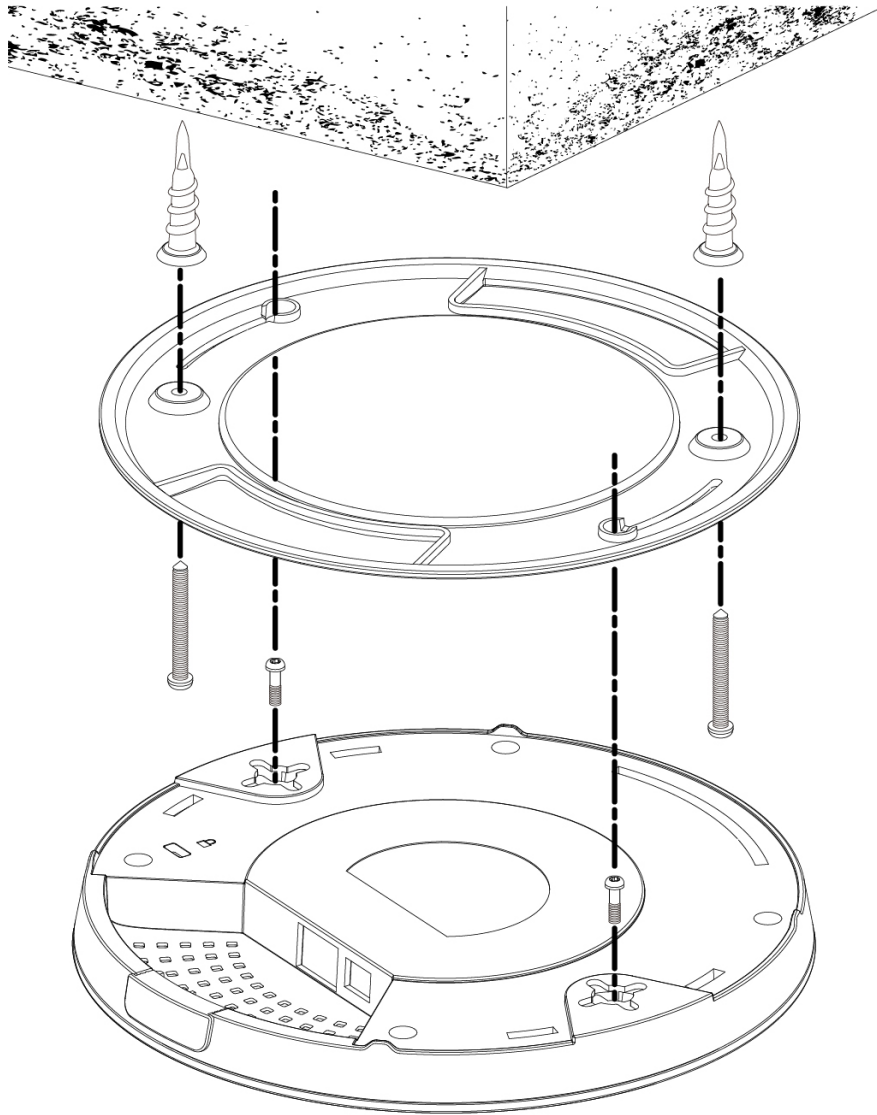

### III-3. T-Rail Mount

To mount the access point to a T-Rail, please follow the instructions below and refer to diagram **C**, **D** & **E**.

1. Select the correct size T-Rail bracket from the two sizes which are included in the package contents.
2. Attach the T-Rail bracket **i** to hole **ii** using screw **iii** (x 2) as shown in **C**.

 ***If you need more space between the access point and the T-Rail, then additionally use bracket **iv** between bracket **i** and hole **ii** (x 2), and use the longer screws (x 2) included in the package contents.***

3. Clip the access point onto your T-Rail using the now attached T-Rail bracket.

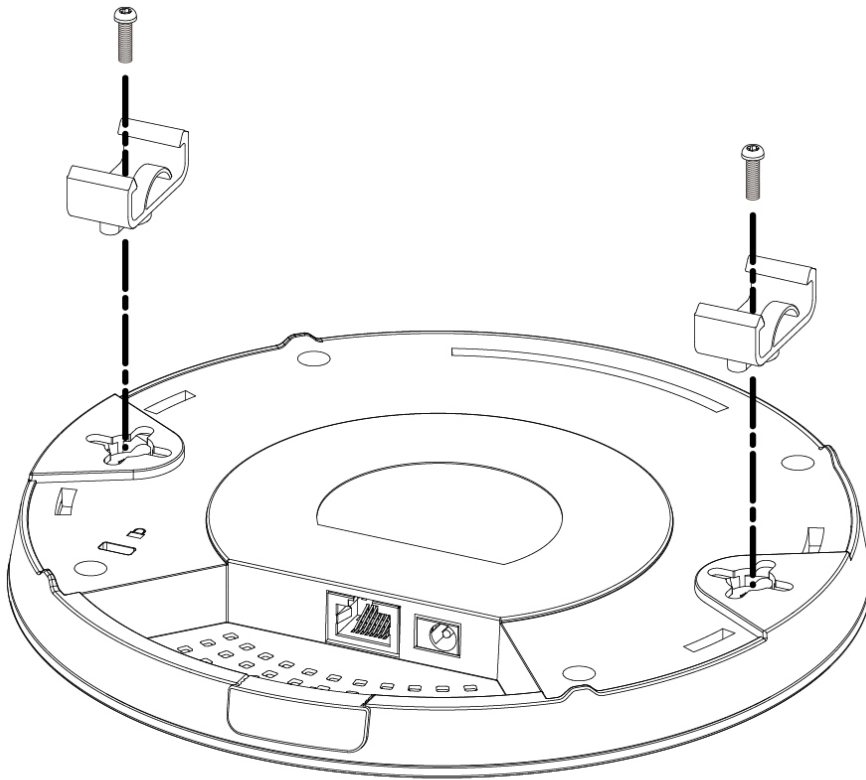

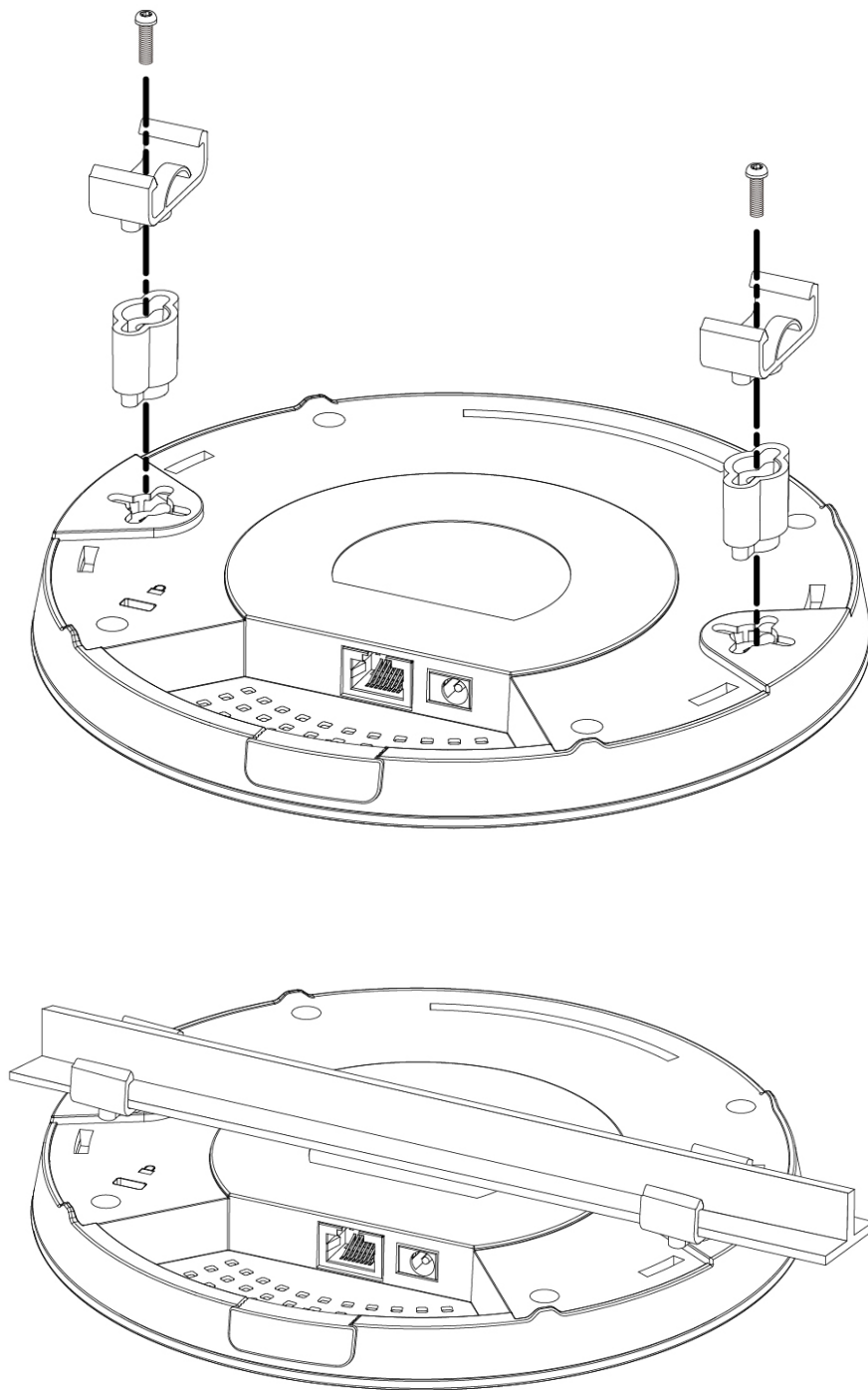

## IV. Browser Based Configuration Interface

The browser-based configuration interface enables you to configure the access point's advanced features. The CAP1200 features a range of advanced functions such as MAC filtering, MAC RADIUS authentication, VLAN configurations, up to 32 SSIDs and many more. To access the browser based configuration interface:

1. Connect a computer to your access point using an Ethernet cable.
2. Enter your access point's IP address in the URL bar of a web browser. The access point's default IP address is **192.168.2.2**.
3. You will be prompted for a username and password. The default username is "admin" and the default password is "1234", though it was recommended that you change the password during setup (see II-2. **Basic Settings**).



*If you cannot remember your password, reset the access point back to its factory default settings. Refer to I-5. Reset*

4. You will arrive at the "System Information" screen shown below.

The screenshot displays the EDIMAX Pro CAP1200 web interface. The top navigation bar includes "Home | Logout | Global (English)". The main menu has tabs for "Information", "Network Settings", "Wireless Settings", "Management", and "Advanced". The "Information" tab is active, and the "System Information" sub-tab is selected. The left sidebar shows a menu with "System Information", "Wireless Clients", "Wireless Monitor", and "Log". The main content area shows the "System Information" page with a table of system details:

System	
Model	CAP1200
Product Name	AP801F0275EA6E
Uptime	0 day 00:29:08
Boot from	Internal memory
Version	0.0.4
MAC Address	80:1F:02:75:EA:6E
Management VLAN ID	1
IP Address	192.168.2.2
Default Gateway	---
DNS	---
DHCP Server	---

5. Use the menu across the top and down the left side to navigate.

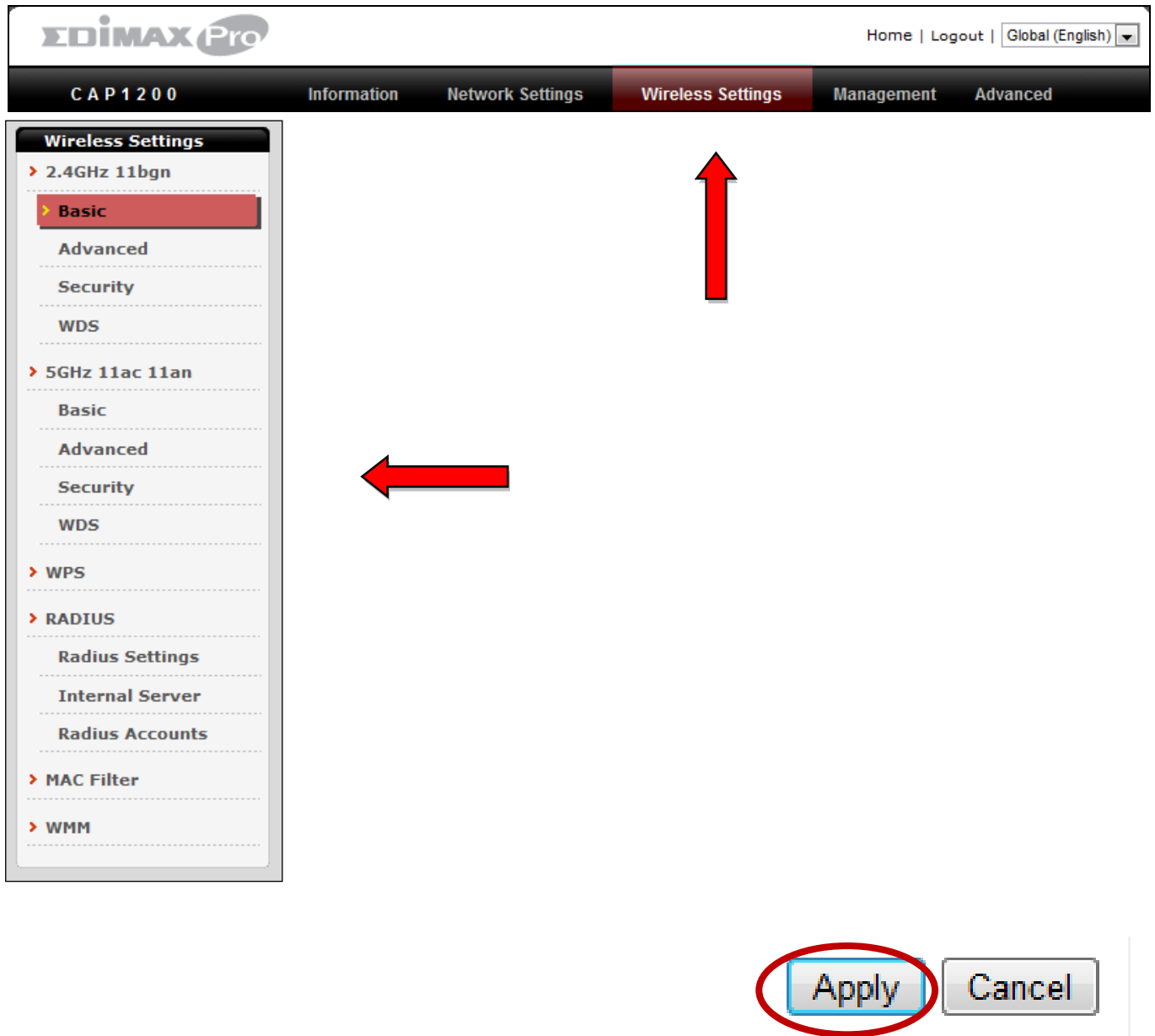

6. Click “Apply” to save changes and reload the access point, or “Cancel” to cancel changes.



***Please wait a few seconds for the access point to reload after you “Apply” changes, as shown below.***

Configuration is complete. Reloading now... Please wait for  seconds.

7. Please refer to the following chapters for full descriptions of the browser based configuration interface features.

## IV-1. Information

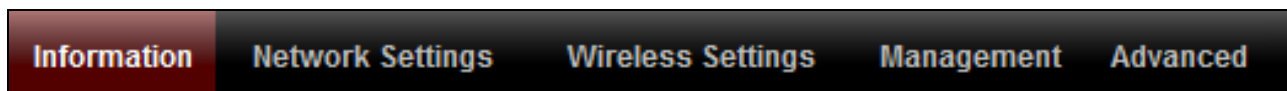

*Screenshots displayed are examples. The information shown on your screen will vary depending on your configuration.*

### IV-1-1. System Information

#### > System Information

The “System Information” page displays basic system information about the access point.

System	
Model	CAP1200
Product Name	AP801F0275EA6E
Uptime	0 day 00:12:57
Boot from	Internal memory
Version	0.0.5
MAC Address	80:1F:02:75:EA:6E
Management VLAN ID	1
IP Address	192.168.2.2
Default Gateway	---
DNS	---
DHCP Server	---

### Wired LAN Port Settings

Wired LAN Port	Status	VLAN Mode/ID
Wired Port (#1)	Connected (100 Mbps Full-Duplex)	Untagged Port / 1

### Wireless 2.4GHz

Status	Enabled
MAC Address	00:AA:BB:CC:DD:10
Channel	Ch 4 + 8 (Auto)
Transmit Power	100%

### Wireless 2.4GHz /SSID

SSID	Authentication Method	Encryption Type	VLAN ID	Additional Authentication	Wireless Client Isolation
CAP1200-CCDD10_G	No Authentication	No Encryption	1	No additional authentication	Disabled

### Wireless 2.4GHz /WDS Disabled

MAC Address	Encryption Type	VLAN Mode/ID
No WDS entries.		

### Wireless 5GHz

Status	Enabled
MAC Address	00:AA:BB:CC:DD:11
Channel	Ch 36 + 40 + 44 + 48 (Auto)
Transmit Power	100%

### Wireless 5GHz /SSID

SSID	Authentication Method	Encryption Type	VLAN ID	Additional Authentication	Wireless Client Isolation
CAP1200-CCDD10_A	No Authentication	No Encryption	1	No additional authentication	Disabled

### Wireless 5GHz /WDS Disabled

MAC Address	Encryption Type	VLAN Mode/ID
No WDS entries.		

Refresh



System	
<b>Model</b>	Displays the model number of the access point.
<b>Product Name</b>	Displays the product name for reference, which consists of “AP” plus the MAC address.
<b>Uptime</b>	Displays the total time since the device was turned on.
<b>Boot From</b>	Displays information for the booted hardware.
<b>Version</b>	Displays the firmware version.
<b>MAC Address</b>	Displays the access point’s MAC address.
<b>Management VLAN ID</b>	Displays the management VLAN ID.
<b>IP Address</b>	Displays the IP address of this device. Click “Refresh” to update this value.
<b>Default Gateway</b>	Displays the IP address of the default gateway.
<b>DNS</b>	IP address of DNS (Domain Name Server).
<b>DHCP Server</b>	IP address of DHCP Server.

Wired LAN Port Settings	
<b>Wired LAN Port</b>	Specifies which LAN port.
<b>Status</b>	Displays the status of the LAN port (connected or disconnected).
<b>VLAN Mode/ID</b>	Displays the VLAN mode (tagged or untagged) and VLAN ID for the LAN port. See <b>IV-2-3. VLAN</b>

Wireless 2.4GHz (5GHz)	
<b>Status</b>	Displays the status of the 2.4GHz or 5GHz wireless (enabled or disabled).
<b>MAC Address</b>	Displays the access point’s MAC address.
<b>Channel</b>	Displays the channel number the specified wireless frequency is using for broadcast.
<b>Transmit Power</b>	Displays the wireless radio transmit power level as a percentage.

Wireless 2.4GHz (5GHz) / SSID	
<b>SSID</b>	Displays the SSID name(s) for the specified frequency.
<b>Authentication Method</b>	Displays the authentication method for the specified SSID. See <b>IV-3. Wireless Settings</b>
<b>Encryption Type</b>	Displays the encryption type for the specified SSID. See <b>IV-3. Wireless Settings</b>
<b>VLAN ID</b>	Displays the VLAN ID for the specified SSID. See <b>IV-2-3. VLAN</b>
<b>Additional Authentication</b>	Displays the additional authentication type for the specified SSID. See <b>IV-3. Wireless Settings</b>
<b>Wireless Client Isolation</b>	Displays whether wireless client isolation is in use for the specified SSID. See <b>IV-2-3. VLAN</b>

Wireless 2.4GHz (5GHz) / WDS Status	
<b>MAC Address</b>	Displays the peer access point's MAC address.
<b>Encryption Type</b>	Displays the encryption type for the specified WDS. See <b>IV-3-1-4. WDS</b>
<b>VLAN Mode/ID</b>	Displays the VLAN ID for the specified WDS. See <b>IV-3-1-4. WDS</b>

<b>Refresh</b>	Click to refresh all information.
----------------	-----------------------------------

## IV-1-2. Wireless Clients

### > Wireless Clients

The “Wireless Clients” page displays information about all wireless clients connected to the access point on the 2.4GHz or 5GHz frequency.

Refresh time	
Auto Refresh time	<input checked="" type="radio"/> 5 seconds <input type="radio"/> 1 second <input type="radio"/> Disable
Manual Refresh	<input type="button" value="Refresh"/>

2.4GHz WLAN Client Table							
#	SSID	MAC Address	Tx	Rx	Signal (%)	Connected Time	Idle Time
1	CAP1200-CCDD10_G	F8:A9:D0:0B:7D:A8	0 Bytes	1.8 KBytes	100	25 secs	3

5GHz WLAN Client Table							
#	SSID	MAC Address	Tx	Rx	Signal (%)	Connected Time	Idle Time
No wireless client							

Refresh time	
<b>Auto Refresh Time</b>	Select a time interval for the client table list to automatically refresh.
<b>Manual Refresh</b>	Click refresh to manually refresh the client table.

2.4GHz (5GHz) WLAN Client Table	
<b>SSID</b>	Displays the SSID which the client is connected to.
<b>MAC Address</b>	Displays the MAC address of the client.
<b>Tx</b>	Displays the total data packets transmitted by the specified client.
<b>Rx</b>	Displays the total data packets received by the specified client.
<b>Signal (%)</b>	Displays the wireless signal strength for the specified client.

<b>Connected Time</b>	Displays the total time the wireless client has been connected to the access point.
<b>Idle Time</b>	Client idle time is the time for which the client has not transmitted any data packets i.e. is idle.
<b>Vendor</b>	The vendor of the client's wireless adapter is displayed here.

### IV-1-3. Wireless Monitor

**➤ Wireless Monitor** Wireless Monitor is a tool built into the access point to scan and monitor the surrounding wireless environment. Select a frequency and click “Scan” to display a list of all SSIDs within range along with relevant details for each SSID.

Wireless 2.4GHz						
Ch	SSID	MAC Address	Security	Signal (%)	Type	Vendor
1	Matt	00:E0:4C:81:96:C1	WPA2PSK/AES	100	11b/g/n	REALTEK SEMICONDUCTOR CORP.

Wireless 5GHz						
Ch	SSID	MAC Address	Security	Signal (%)	Type	Vendor
You can click Scan button to start.						

Wireless Monitor	
<b>Site Survey</b>	Select which frequency (or both) to scan, and click “Scan” to begin.
<b>Channel Survey Result</b>	After a scan is complete, click “Export” to save the results to local storage.

Site Survey Results	
<b>Ch</b>	Displays the channel number used by the specified SSID.
<b>SSID</b>	Displays the SSID identified by the scan.
<b>MAC Address</b>	Displays the MAC address of the wireless router/access point for the specified SSID.
<b>Security</b>	Displays the authentication/encryption type of the specified SSID.

<b>Signal (%)</b>	Displays the current signal strength of the SSID.
<b>Type</b>	Displays the 802.11 wireless networking standard(s) of the specified SSID.
<b>Vendor</b>	Displays the vendor of the wireless router/access point for the specified SSID.

## IV-1-4. Log

### > System Log

The system log displays system operation information such as up time and connection processes. This information is useful for network administrators.



***When the log is full, old entries are overwritten.***

```
Jan 1 00:02:49 [SYSTEM]: LAN, Port[1] link status is changed to down
Jan 1 00:02:25 [SYSTEM]: LAN, Port[1] link is changed to 100Mbps-Full-Duplex
Jan 1 00:00:58 [SYSTEM]: WLAN[2.4G], Best channel selection start, switch to channel 1 + 5
Jan 1 00:00:38 [SYSTEM]: WLAN[5G], Skip Best channel selection and wait for next time
Jan 1 00:00:12 [SYSTEM]: LAN, Port[1] link status is changed to down
Jan 1 00:00:12 [SYSTEM]: LAN, Port[0] link status is changed to down
Jan 1 00:00:11 [SYSTEM]: TFTP server, Stopping
Jan 1 00:00:11 [SYSTEM]: FTP server, Stopping
Jan 1 00:00:11 [SYSTEM]: HTTPS, start
Jan 1 00:00:11 [SYSTEM]: HTTP, start
Jan 1 00:00:10 [SYSTEM]: LEDs, light on specific LEDs
Jan 1 00:00:07 [SYSTEM]: WLAN[5G], Channel = AutoSelect
Jan 1 00:00:07 [SYSTEM]: WLAN[5G], Wireless Mode = 11ACVHT80
Jan 1 00:00:02 [SYSTEM]: WLAN[2.4G], Channel = AutoSelect
Jan 1 00:00:02 [SYSTEM]: WLAN[2.4G], Wireless Mode = 11NGHT40MINUS
Jan 1 00:00:02 [SYSTEM]: DHCP, start
Jan 1 00:00:02 [SYSTEM]: LAN, start
Jan 1 00:00:02 [SYSTEM]: Bridge, start
```

<b>Save</b>	Click to save the log as a file on your local computer.
<b>Clear</b>	Clear all log entries.
<b>Refresh</b>	Refresh the current log.

The following information/events are recorded by the log:

- ◆ **Wireless Client**  
*Connected & disconnected*  
*Key exchange success & fail*
- ◆ **Authentication**  
*Authentication fail or successful.*
- ◆ **Association**  
*Success or fail*
- ◆ **WPS**  
*M1 - M8 messages*  
*WPS success*
- ◆ **Change Settings**
- ◆ **System Boot**  
*Displays current model name*
- ◆ **NTP Client**
- ◆ **Wired Link**  
*LAN Port link status and speed status*
- ◆ **Proxy ARP**  
*Proxy ARP module start & stop*
- ◆ **Bridge**  
*Bridge start & stop.*
- ◆ **SNMP**  
*SNMP server start & stop.*
- ◆ **HTTP**  
*HTTP start & stop.*
- ◆ **HTTPS**  
*HTTPS start & stop.*
- ◆ **SSH**  
*SSH-client server start & stop.*
- ◆ **Telnet**  
*Telnet-client server start or stop.*
- ◆ **WLAN (2.4G)**  
*WLAN (2.4G) channel status and country/region status*
- ◆ **WLAN (5G)**  
*WLAN (5G) channel status and country/region status*
- ◆ **ADT**



## IV-2. Network Settings

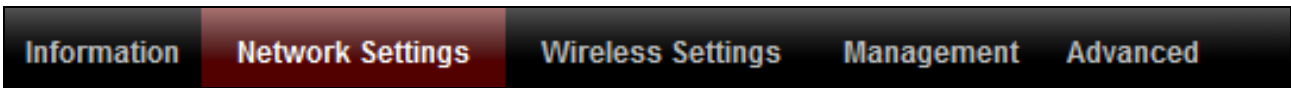

 *Screenshots displayed are examples. The information shown on your screen will vary depending on your configuration.*

### IV-2-1. LAN-Side IP Address

 **LAN-side IP Address** The “LAN-side IP address” page allows you to configure your access point on your Local Area Network (LAN). You can enable the access point to dynamically receive an IP address from your router’s DHCP server or you can specify a static IP address for your access point, as well as configure DNS servers.

 *The access point’s default IP address is 192.168.2.2.*

LAN-side IP Address	
<b>IP Address Assignment</b>	Select “DHCP Client” for your access point to be assigned a dynamic IP address from your router’s DHCP server, or select “Static IP” to manually specify a static/fixed IP address for your access point (below).
<b>IP Address</b>	Specify the IP address here. This IP address will be assigned to your access point and will

	replace the default IP address.
<b>Subnet Mask</b>	Specify a subnet mask. The default value is 255.255.255.0
<b>Default Gateway</b>	For DHCP users, select “From DHCP” to get default gateway from your DHCP server or “User-Defined” to enter a gateway manually. For static IP users, the default value is blank.

DHCP users can select to get DNS servers’ IP address from DHCP or manually enter a value. For static IP users, the default value is blank.

<b>Primary Address</b>	DHCP users can select “From DHCP” to get primary DNS server’s IP address from DHCP or “User-Defined” to manually enter a value. For static IP users, the default value is blank.
<b>Secondary Address</b>	Users can manually enter a value when DNS server’s primary address is set to “User-Defined”.

## IV-2-2. LAN Port

### > LAN Port

The “LAN Port” page allows you to configure the settings for your access point’s two wired LAN (Ethernet) ports.

Wired LAN Port Settings				
Wired LAN Port	Enable	Speed & Duplex	Flow Control	802.3az
Wired Port (#1)	Enabled ▾	Auto ▾	Enabled ▾	Enabled ▾

<b>Wired LAN Port</b>	Identifies LAN port 1.
<b>Enable</b>	Enable/disable LAN port.
<b>Speed &amp; Duplex</b>	Select a speed & duplex type for LAN port, or use the “Auto” value. LAN ports can operate up to 1000Mbps and full-duplex enables simultaneous data packets transfer/receive.
<b>Flow Control</b>	Enable/disable flow control. Flow control can pause new session request until current data processing is complete, in order to avoid device overloads under heavy traffic.
<b>802.3az</b>	Enable/disable 802.3az. 802.3az is an Energy Efficient Ethernet feature which disables unused interfaces to reduce power usage.

## IV-2-3. VLAN

### > VLAN

The “VLAN” (Virtual Local Area Network) enables you to configure VLAN settings. A VLAN is a local area network which maps workstations virtually instead of physically and allows you to group together or isolate users from each other. VLAN IDs 1 – 4094 are supported.



**VLAN IDs in the range 1 – 4094 are supported.**

VLAN Interface		
<b>Wired LAN Port</b>	<b>VLAN Mode</b>	<b>VLAN ID</b>
Wired Port (#1)	Untagged Port ▾	1
<b>Wireless 2.4GHz</b>	<b>VLAN Mode</b>	<b>VLAN ID</b>
SSID [CAP1200-CCDD10_G]	Untagged Port	1
<b>Wireless 5GHz</b>	<b>VLAN Mode</b>	<b>VLAN ID</b>
SSID [CAP1200-CCDD10_A]	Untagged Port	1

  

Management VLAN	
<b>VLAN ID</b>	1

VLAN Interface	
<b>Wired LAN Port/Wireless</b>	Identifies LAN port 1 and wireless SSIDs (2.4GHz or 5GHz).
<b>VLAN Mode</b>	Select “Tagged Port” or “Untagged Port” for LAN interface.
<b>VLAN ID</b>	Set a VLAN ID for specified interface, if “Untagged Port” is selected.

Management VLAN	
<b>VLAN ID</b>	Specify the VLAN ID of the management VLAN. Only the hosts belonging to the same VLAN can manage the device.

## IV-3. Wireless Settings

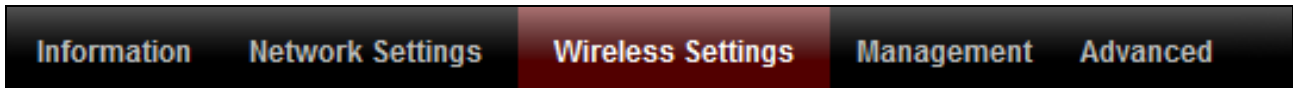

*Screenshots displayed are examples. The information shown on your screen will vary depending on your configuration.*

### IV-3-1. 2.4GHz 11bgn



The “2.4GHz 11bgn” menu allows you to view and configure information for your access point’s 2.4GHz wireless network across four

categories: Basic, Advanced, Security and WDS.

## IV-3-1-1. Basic

### > Basic

The “Basic” screen displays basic settings for your access point’s 2.4GHz Wi-Fi network (s).

2.4GHz Basic Settings	
Wireless	<input checked="" type="radio"/> Enable <input type="radio"/> Disable
Band	11b/g/n ▼
Enable SSID number	1 ▼
SSID1	CAP1200-CCDD10_G VLAN ID 1
Auto Channel	<input checked="" type="radio"/> Enable <input type="radio"/> Disable
Auto Channel Range	Ch 1 - 11 ▼
Auto Channel Interval	One day ▼ <input type="checkbox"/> Change channel even if clients are connected
Channel Bandwidth	Auto ▼
BSS BasicRateSet	1,2,5.5,11 Mbps ▼



Auto Channel	<input type="radio"/> Enable <input checked="" type="radio"/> Disable
Channel	Ch 11, 2462MHz ▼
Channel Bandwidth	Auto, +Ch 7 ▼
BSS BasicRateSet	1,2,5.5,11 Mbps ▼

<b>Wireless</b>	Enable or disable the access point's 2.4GHz wireless radio. When disabled, no 2.4GHz SSIDs will be active.
<b>Band</b>	Select the wireless standard used for the access point. Combinations of 802.11b, 802.11g & 802.11n can be selected.
<b>Enable SSID Number</b>	Select how many SSIDs to enable for the 2.4GHz frequency from the drop down menu. A maximum of 16 can be enabled.
<b>SSID#</b>	Enter the SSID name for the specified SSID (up to 16). The SSID can consist of any combination of up to 32 alphanumeric characters.
<b>VLAN ID</b>	Specify a VLAN ID for each SSID.
<b>Auto Channel</b>	Enable/disable auto channel selection. Auto channel selection will automatically set the wireless channel for the access point's 2.4GHz frequency based on availability and potential interference. When disabled, select a channel manually as shown in the next table.
<b>Auto Channel Range</b>	Select a range from which the auto channel setting (above) will choose a channel.
<b>Auto Channel Interval</b>	Specify a frequency for how often the auto channel setting will check/reassign the wireless channel. Check/uncheck the "Change channel even if clients are connected" box according to your preference.
<b>Channel Bandwidth</b>	Set the channel bandwidth: 20MHz (lower performance but less interference), 40MHz (higher performance but potentially higher interference) or Auto (automatically select based on interference level).
<b>BSS BasicRateSet</b>	Set a Basic Service Set (BSS) rate: this is a series of rates to control communication frames for wireless clients.

When auto channel is disabled, select a wireless channel manually:

<b>Channel</b>	Select a wireless channel from 1 – 11 (1-13).
<b>Channel Bandwidth</b>	Set the channel bandwidth: 20MHz (lower performance but less interference), 40MHz (higher performance but potentially higher interference) or Auto (automatically select based on interference level).
<b>BSS BasicRate Set</b>	Set a Basic Service Set (BSS) rate: this is a series of rates to control communication frames for wireless clients.



## IV-3-1-2. Advanced

### > Advanced

These settings are for experienced users only. Please do not change any of the values on this page unless you are already familiar with these functions.



***Changing these settings can adversely affect the performance of your access point.***

2.4GHz Advanced Settings	
Contention Slot	Short ▾
Preamble Type	Short ▾
Guard Interval	Short GI ▾
802.11g Protection	<input checked="" type="radio"/> Enable <input type="radio"/> Disable
802.11n Protection	<input checked="" type="radio"/> Enable <input type="radio"/> Disable
DTIM Period	1 (1-255)
RTS Threshold	2347 (1-2347)
Fragment Threshold	2346 (256-2346)
Multicast Rate	Auto ▾
Tx Power	100% ▾
Beacon Interval	100 (40-1000 ms)
Station idle timeout	60 (30-65535 seconds)

<b>Contention Slot</b>	Select “Short” or “Long” – this value is used for contention windows in WMM (see <b>IV-3-6. WMM</b> ).
<b>Preamble Type</b>	Set the wireless radio preamble type. The preamble type in 802.11 based wireless communication defines the length of the CRC (Cyclic Redundancy Check) block for communication between the access point and roaming wireless adapters. The default value is “Short Preamble”.
<b>Guard Interval</b>	Set the guard interval. A shorter interval can improve performance.

<b>802.11g Protection</b>	Enable/disable 802.11g protection, which increases reliability but reduces bandwidth (clients will send Request to Send (RTS) to access point, and access point will broadcast Clear to Send (CTS), before a packet is sent from client.)
<b>802.11n Protection</b>	Enable/disable 802.11n protection, which increases reliability but reduces bandwidth (clients will send Request to Send (RTS) to access point, and access point will broadcast Clear to Send (CTS), before a packet is sent from client.)
<b>DTIM Period</b>	Set the DTIM (delivery traffic indication message) period value of the wireless radio. The default value is 1.
<b>RTS Threshold</b>	Set the RTS threshold of the wireless radio. The default value is 2347.
<b>Fragment Threshold</b>	Set the fragment threshold of the wireless radio. The default value is 2346.
<b>Multicast Rate</b>	Set the transfer rate for multicast packets or use the "Auto" setting.
<b>Tx Power</b>	Set the power output of the wireless radio. You may not require 100% output power. Setting a lower power output can enhance security since potentially malicious/unknown users in distant areas will not be able to access your signal.
<b>Beacon Interval</b>	Set the beacon interval of the wireless radio. The default value is 100.
<b>Station idle timeout</b>	Set the interval for keepalive messages from the access point to a wireless client to verify if the station is still alive/active.

### IV-3-1-3. Security

#### > Security

The access point provides various security options (wireless data encryption). When data is encrypted, information transmitted wirelessly cannot be read by anyone who does not know the correct encryption key.



***It's essential to configure wireless security in order to prevent unauthorised access to your network.***



***Select hard-to-guess passwords which include combinations of numbers, letters and symbols, and change your password regularly.***

2.4GHz Wireless Security Settings	
SSID	CAP1200-CCDD10_G ▾
Broadcast SSID	Enable ▾
Wireless Client Isolation	Disable ▾
Load Balancing	50 /50
Authentication Method	No Authentication ▾
Additional Authentication	No additional authentication ▾

<b>SSID Selection</b>	Select which SSID to configure security settings for.
<b>Broadcast SSID</b>	Enable or disable SSID broadcast. When enabled, the SSID will be visible to clients as an available Wi-Fi network. When disabled, the SSID will not be visible as an available Wi-Fi network to clients – clients must manually enter the SSID in order to connect. A hidden (disabled) SSID is typically more secure than a visible (enabled) SSID.
<b>Wireless Client Isolation</b>	Enable or disable wireless client isolation. Wireless client isolation prevents clients connected to the access point from communicating with each other and improves security. Typically, this function is useful for corporate environments or public hot spots and can prevent brute force attacks on clients' usernames and passwords.
<b>Load Balancing</b>	Load balancing limits the number of wireless clients connected to an SSID. Set a load balancing value (maximum 50).
<b>Authentication Method</b>	Select an authentication method from the drop down menu and refer to the information below appropriate for your method.
<b>Additional Authentication</b>	Select an additional authentication method from the drop down menu and refer to the information below ( <b>IV-3-1-3-6.</b> ) appropriate for your method.

### IV-3-1-3-1. No Authentication

Authentication is disabled and no password/key is required to connect to the access point.



***Disabling wireless authentication is not recommended. When disabled, anybody within range can connect to your device's SSID.***

### IV-3-1-3-2. WEP

WEP (Wired Equivalent Privacy) is a basic encryption type. For a higher level of security consider using WPA encryption.

<b>Key Length</b>	Select 64-bit or 128-bit. 128-bit is more secure than 64-bit and is recommended.
<b>Key Type</b>	Choose from "ASCII" (any alphanumerical character 0-9, a-z and A-Z) or "Hex" (any characters from 0-9, a-f and A-F).
<b>Default Key</b>	Select which encryption key (1 – 4 below) is the default key. For security purposes, you can set up to four keys (below) and change which is the default key.
<b>Encryption Key 1 – 4</b>	Enter your encryption key/password according to the format you selected above.

### IV-3-1-3-3. IEEE802.1x/EAP

<b>Key Length</b>	Select 64-bit or 128-bit. 128-bit is more secure than 64-bit and is recommended.
-------------------	--

### IV-3-1-3-4. WPA-PSK

WPA-PSK is a secure wireless encryption type with strong data protection and user authentication, utilizing 128-bit encryption keys.

<b>WPA Type</b>	Select from WPA/WPA2 Mixed Mode-PSK, WPA2 or WPA only. WPA2 is safer than WPA only, but not supported by all wireless clients. Please make sure your wireless client supports your selection.
<b>Encryption</b>	Select "TKIP/AES Mixed Mode" or "AES" encryption type.
<b>Key Renewal Interval</b>	Specify a frequency for key renewal in minutes.
<b>Pre-Shared Key</b>	Choose from "Passphrase" (8 – 63

<b>Type</b>	alphanumeric characters) or “Hex” (up to 64 characters from 0-9, a-f and A-F).
<b>Pre-Shared Key</b>	Please enter a security key/password according to the format you selected above.

#### IV-3-1-3-5. WPA-EAP

<b>WPA Type</b>	Select from WPA/WPA2 Mixed Mode-EAP, WPA2-EAP or WPA-EAP.
<b>Encryption</b>	Select “TKIP/AES Mixed Mode” or “AES” encryption type.
<b>Key Renewal Interval</b>	Specify a frequency for key renewal in minutes.



***WPA-EAP must be disabled to use MAC-RADIUS authentication.***

#### IV-3-1-3-6. Additional Authentication

Additional wireless authentication methods can also be used:

##### **MAC Address Filter**

Restrict wireless clients access based on MAC address specified in the MAC filter table.



***See IV-3-5.MAC Filter to configure MAC filtering.***

##### **MAC Filter & MAC-RADIUS Authentication**

Restrict wireless clients access using both of the above MAC filtering & RADIUS authentication methods.

##### **MAC-RADIUS Authentication**

Restrict wireless clients access based on MAC address via a RADIUS server, or password authentication via a RADIUS server.



***See IV-3-4.RADIUS to configure RADIUS servers.***



***WPS must be disabled to use MAC-RADIUS authentication. See IV-3-3. for WPS settings.***

MAC RADIUS Password

- Use MAC address
- Use the following password

**MAC RADIUS Password**

Select whether to use MAC address or password authentication via RADIUS server. If you select “Use the following password”, enter the password in the field below. The password should match the “Shared Secret” used in **IV-3-4. RADIUS.**

## IV-3-1-4. WDS

**> WDS** Wireless Distribution System (WDS) can bridge/repeat access points together in an extended network. WDS settings can be configured as shown below.



***When using WDS, configure the IP address of each access point to be in the same subnet and ensure there is only one active DHCP server among connected access points, preferably on the WAN side.***

WDS must be configured on each access point, using correct MAC addresses. All access points should use the same wireless channel and encryption method.

2.4GHz	
WDS Functionality	Disabled <input type="button" value="v"/>
Local MAC Address	Disabled WDS with AP Dedicated WDS

WDS Peer Settings	
WDS #1	MAC Address <input type="text"/>
WDS #2	MAC Address <input type="text"/>
WDS #3	MAC Address <input type="text"/>
WDS #4	MAC Address <input type="text"/>

WDS VLAN	
VLAN Mode	Untagged Port <input type="button" value="v"/> (Enter at least one MAC address.)
VLAN ID	<input type="text" value="1"/>

WDS Encryption method	
Encryption	None <input type="button" value="v"/> (Enter at least one MAC address.)



2.4GHz	
<b>WDS Functionality</b>	Select “WDS with AP” to use WDS with access point or “Dedicated WDS” to use WDS and also block communication with regular wireless clients. When WDS is used, each access point should be configured with corresponding MAC addresses, wireless channel and wireless encryption method.
<b>Local MAC Address</b>	Displays the MAC address of your access point.

WDS Peer Settings	
<b>WDS #</b>	Enter the MAC address for up to four other WDS devices you wish to connect.

WDS VLAN	
<b>VLAN Mode</b>	Specify the WDS VLAN mode to “Untagged Port” or “Tagged Port”.
<b>VLAN ID</b>	Specify the WDS VLAN ID when “Untagged Port” is selected above.

WDS Encryption method	
<b>Encryption</b>	Select whether to use “None” or “AES” encryption and enter a pre-shared key for AES consisting of 8-63 alphanumeric characters.

## IV-3-2. 5GHz 11ac 11an

### ➤ 5GHz 11ac 11an

The “5GHz 11ac 11an” menu allows you to view and configure information for your access point’s 5GHz wireless network across four categories: Basic, Advanced, Security and WDS.

### IV-3-2-1. Basic

#### ➤ Basic

The “Basic” screen displays basic settings for your access point’s 5GHz Wi-Fi network (s).

5GHz Basic Settings	
Wireless	<input checked="" type="radio"/> Enable <input type="radio"/> Disable
Band	11a/n/ac ▼
Enable SSID number	1 ▼
SSID1	CAP1200-CCDD10_A VLAN ID 1
Auto Channel	<input checked="" type="radio"/> Enable <input type="radio"/> Disable
Auto Channel Range	Band 1 ▼
Auto Channel Interval	One day ▼ <input type="checkbox"/> Change channel even if clients are connected
Channel Bandwidth	Auto 80/40/20 MHz ▼
BSS BasicRateSet	6,12,24 Mbps ▼



Auto Channel	<input type="radio"/> Enable <input checked="" type="radio"/> Disable
Channel	Ch 36, 5.18GHz ▼
Channel Bandwidth	Auto 80/40/20 MHz ▼
BSS BasicRateSet	6,12,24 Mbps ▼

#### Wireless

Enable or disable the access point’s 5GHz wireless radio. When disabled, no 5GHz SSIDs

	will be active.
<b>Band</b>	Select the wireless standard used for the access point. Combinations of 802.11a, 802.11n & 802.11ac can be selected.
<b>Enable SSID Number</b>	Select how many SSIDs to enable for the 5GHz frequency from the drop down menu. A maximum of 16 can be enabled.
<b>SSID#</b>	Enter the SSID name for the specified SSID (up to 16). The SSID can consist of any combination of up to 32 alphanumeric characters.
<b>VLAN ID</b>	Specify a VLAN ID for each SSID.
<b>Auto Channel</b>	Enable/disable auto channel selection. Auto channel selection will automatically set the wireless channel for the access point's 5GHz frequency based on availability and potential interference. When disabled, select a channel manually as shown in the next table.
<b>Auto Channel Range</b>	Select a range from which the auto channel setting (above) will choose a channel.
<b>Auto Channel Interval</b>	Specify a frequency for how often the auto channel setting will check/reassign the wireless channel. Check/uncheck the "Change channel even if clients are connected" box according to your preference.
<b>Channel Bandwidth</b>	Set the channel bandwidth: 20MHz (lower performance but less interference), Auto 40/20MHz or Auto 80/40/20MHz (automatically select based on interference level).
<b>BSS BasicRate Set</b>	Set a Basic Service Set (BSS) rate: this is a series of rates to control communication frames for wireless clients.

When auto channel is disabled, select a wireless channel manually:

<b>Channel</b>	Select a wireless channel.
<b>Channel Bandwidth</b>	Set the channel bandwidth: 20MHz (lower performance but less interference), Auto 40/20MHz or Auto 80/40/20MHz

	(automatically select based on interference level).
<b>BSS BasicRate Set</b>	Set a Basic Service Set (BSS) rate: this is a series of rates to control communication frames for wireless clients.

## IV-3-2-2. Advanced

### > Advanced

These settings are for experienced users only. Please do not change any of the values on this page unless you are already familiar with these functions.



***Changing these settings can adversely affect the performance of your access point.***

5GHz Advanced Settings	
Guard Interval	Short GI ▾
802.11n Protection	<input checked="" type="radio"/> Enable <input type="radio"/> Disable
DTIM Period	1 (1-255)
RTS Threshold	2347 (1-2347)
Fragment Threshold	2346 (256-2346)
Multicast Rate	Auto ▾
Tx Power	100% ▾
Beacon Interval	100 (40-1000 ms)
Station idle timeout	60 (30-65535 seconds)

<b>Guard Interval</b>	Set the guard interval. A shorter interval can improve performance.
<b>802.11n Protection</b>	Enable/disable 802.11n protection, which increases reliability but reduces bandwidth (clients will send Request to Send (RTS) to access point, and access point will broadcast Clear to Send (CTS), before a packet is sent from client.)
<b>DTIM Period</b>	Set the DTIM (delivery traffic indication message) period value of the wireless radio. The default value is 1.
<b>RTS Threshold</b>	Set the RTS threshold of the wireless radio. The default value is 2347.
<b>Fragment Threshold</b>	Set the fragment threshold of the wireless radio. The default value is 2346.
<b>Multicast Rate</b>	Set the transfer rate for multicast packets or use the "Auto" setting.

<b>Tx Power</b>	Set the power output of the wireless radio. You may not require 100% output power. Setting a lower power output can enhance security since potentially malicious/unknown users in distant areas will not be able to access your signal.
<b>Beacon Interval</b>	Set the beacon interval of the wireless radio. The default value is 100.
<b>Station idle timeout</b>	Set the interval for keepalive messages from the access point to a wireless client to verify if the station is still alive/active.

### IV-3-2-3. Security

#### Security

The access point provides various security options (wireless data encryption). When data is encrypted, information transmitted wirelessly cannot be read by anyone who does not know the correct encryption key.

 ***It's essential to configure wireless security in order to prevent unauthorised access to your network.***

 ***Select hard-to-guess passwords which include combinations of numbers, letters and symbols, and change your password regularly.***

5GHz Wireless Security Settings	
SSID	CAP1200-CCDD10_A ▾
Broadcast SSID	Enable ▾
Wireless Client Isolation	Disable ▾
Load Balancing	50 /50
Authentication Method	No Authentication ▾
Additional Authentication	No additional authentication ▾

<b>SSID Selection</b>	Select which SSID to configure security settings for.
<b>Broadcast SSID</b>	Enable or disable SSID broadcast. When enabled, the SSID will be visible to clients as an available Wi-Fi network. When disabled, the SSID will not be visible as an available Wi-Fi network to clients – clients must manually enter the SSID in order to connect. A hidden (disabled) SSID is typically more secure than a visible (enabled) SSID.

<b>Wireless Client Isolation</b>	Enable or disable wireless client isolation. Wireless client isolation prevents clients connected to the access point from communicating with each other and improves security. Typically, this function is useful for corporate environments or public hot spots and can prevent brute force attacks on clients' usernames and passwords.
<b>Load Balancing</b>	Load balancing limits the number of wireless clients connected to an SSID. Set a load balancing value (maximum 50).
<b>Authentication Method</b>	Select an authentication method from the drop down menu and refer to the information below appropriate for your method.
<b>Additional Authentication</b>	Select an additional authentication method from the drop down menu and refer to the information below appropriate for your method.

Please refer back to **IV-3-1-3. Security** for more information on authentication and additional authentication types.



## IV-3-2-4. WDS

### ➤ WDS

Wireless Distribution System (WDS) can bridge/repeat access points together in an extended network. WDS settings can be configured as shown below.



***When using WDS, configure the IP address of each access point to be in the same subnet and ensure there is only one active DHCP server among connected access points, preferably on the WAN side.***

WDS must be configured on each access point, using correct MAC addresses. All access points should use the same wireless channel and encryption method.

5GHz WDS Mode	
WDS Functionality	Disabled
Local MAC Address	Disabled
	WDS with AP
	Dedicated WDS

WDS Peer Settings	
WDS #1	MAC Address <input type="text"/>
WDS #2	MAC Address <input type="text"/>
WDS #3	MAC Address <input type="text"/>
WDS #4	MAC Address <input type="text"/>

WDS VLAN	
VLAN Mode	Untagged Port <input type="text"/> (Enter at least one MAC address.)
VLAN ID	1

Encryption method	
Encryption	None <input type="text"/> (Enter at least one MAC address.)

5GHz WDS Mode	
<b>WDS Functionality</b>	Select “WDS with AP” to use WDS with access point or “Dedicated WDS” to use WDS and also block communication with regular wireless clients. When WDS is used, each access point should be configured with corresponding MAC addresses, wireless channel and wireless encryption method.
<b>Local MAC Address</b>	Displays the MAC address of your access point.

WDS Peer Settings	
<b>WDS #</b>	Enter the MAC address for up to four other WDA devices you wish to connect.

WDS VLAN	
<b>VLAN Mode</b>	Specify the WDS VLAN mode to “Untagged Port” or “Tagged Port”.
<b>VLAN ID</b>	Specify the WDS VLAN ID when “Untagged Port” is selected above.

WDS Encryption	
<b>Encryption</b>	Select whether to use “None” or “AES” encryption and enter a pre-shared key for AES with 8-63 alphanumeric characters.

### IV-3-3. WPS

#### > WPS

Wi-Fi Protected Setup is a simple way to establish connections between WPS compatible devices. WPS can be activated on compatible devices by pushing a WPS button on the device or from within the device's firmware/configuration interface (known as PBC or "Push Button Configuration"). When WPS is activated in the correct manner and at the correct time for two compatible devices, they will automatically connect. "PIN code WPS" is a variation of PBC which includes the additional use of a PIN code between the two devices for verification.



***Please refer to manufacturer's instructions for your other WPS device.***

WPS	<input checked="" type="checkbox"/> Enable
-----	--

Apply

WPS	
Product PIN	58327142 <input type="button" value="Generate PIN"/>
Push-button WPS	<input type="button" value="Start"/>
WPS by PIN	<input type="text"/> <input type="button" value="Start"/>

WPS Security	
WPS Status	Not Configured <input type="button" value="Release"/>

<b>WPS</b>	Check/uncheck this box to enable/disable WPS functionality. WPS must be disabled when using MAC-RADIUS authentication (see <b>IV-3-1-3-6 &amp; IV-3-4</b> ).
<b>Product PIN</b>	Displays the WPS PIN code of the device, used for PIN code WPS. You will be required to enter this PIN code into another WPS device for PIN code WPS. Click "Generate PIN" to generate a new WPS PIN code.
<b>Push-Button WPS</b>	Click "Start" to activate WPS on the access point for approximately 2 minutes. This has the same effect as physically pushing the access point's WPS button.
<b>WPS by PIN</b>	Enter the PIN code of another WPS device and click "Start" to attempt to establish a WPS connection for approximately 2 minutes.
<b>WPS Status</b>	WPS security status is displayed here. Click "Release" to clear the existing status.

## IV-3-4. RADIUS

### RADIUS

The RADIUS sub menu allows you to configure the access point's RADIUS server settings, categorized into three submenus: RADIUS settings, Internal Server and RADIUS accounts.

A RADIUS server provides user-based authentication to improve security and offer wireless client control – users can be authenticated before gaining access to a network.

The access point can utilize both a primary and secondary (backup) RADIUS server for each of its wireless frequencies (2.4GHz & 5GHz). External RADIUS servers can be used or the access point's internal RADIUS server can be used.



***To use RADIUS servers, go to “Wireless Settings” → “Security” and select “MAC RADIUS Authentication” → “Additional Authentication” and select “MAC RADIUS Authentication” (see IV-3-1-3. & IV-3-2-3).***

## IV-3-4-1. RADIUS Settings

### ➤ Radius Settings

Configure the RADIUS server settings for 2.4GHz & 5GHz. Each frequency can use an internal or external RADIUS server.

RADIUS Server (2.4GHz)	
<b>Primary RADIUS Server</b>	
RADIUS Type	<input type="radio"/> Internal <input checked="" type="radio"/> External
RADIUS Server	<input type="text"/>
Authentication Port	<input type="text" value="1812"/>
Shared Secret	<input type="text"/>
Session Timeout	<input type="text" value="3600"/> second(s)
Accounting	<input checked="" type="radio"/> Enable <input type="radio"/> Disable
Accounting Port	<input type="text" value="1813"/>
<b>Secondary RADIUS Server</b>	
RADIUS Type	<input type="radio"/> Internal <input checked="" type="radio"/> External
RADIUS Server	<input type="text"/>
Authentication Port	<input type="text" value="1812"/>
Shared Secret	<input type="text"/>
Session Timeout	<input type="text" value="3600"/> second(s)
Accounting	<input checked="" type="radio"/> Enable <input type="radio"/> Disable
Accounting Port	<input type="text" value="1813"/>

## RADIUS Server (5GHz)

Primary RADIUS Server	
RADIUS Type	<input type="radio"/> Internal <input checked="" type="radio"/> External
RADIUS Server	<input type="text"/>
Authentication Port	<input type="text" value="1812"/>
Shared Secret	<input type="text"/>
Session Timeout	<input type="text" value="3600"/> second(s)
Accounting	<input checked="" type="radio"/> Enable <input type="radio"/> Disable
Accounting Port	<input type="text" value="1813"/>

Secondary RADIUS Server	
RADIUS Type	<input type="radio"/> Internal <input checked="" type="radio"/> External
RADIUS Server	<input type="text"/>
Authentication Port	<input type="text" value="1812"/>
Shared Secret	<input type="text"/>
Session Timeout	<input type="text" value="3600"/> second(s)
Accounting	<input checked="" type="radio"/> Enable <input type="radio"/> Disable
Accounting Port	<input type="text" value="1813"/>

<b>RADIUS Type</b>	Select “Internal” to use the access point’s built-in RADIUS server or “external” to use an external RADIUS server.
<b>RADIUS Server</b>	Enter the RADIUS server host IP address.
<b>Authentication Port</b>	Set the UDP port used in the authentication protocol of the RADIUS server. Value must be between 1 – 65535.
<b>Shared Secret</b>	Enter a shared secret/password between 1 – 99 characters in length. This should match the “MAC-RADIUS” password used in <b>IV-3-1-3-6</b> or <b>IV-3-2-3</b> .
<b>Session Timeout</b>	Set a duration of session timeout in seconds between 0 – 86400.
<b>Accounting</b>	Enable or disable RADIUS accounting.

<b>Accounting Port</b>	When accounting is enabled (above), set the UDP port used in the accounting protocol of the RADIUS server. Value must be between 1 – 65535.
------------------------	---

## IV-3-4-2. Internal Server

**Internal Server** The access point features a built-in RADIUS server which can be configured as shown below used when “Internal” is selected for “RADIUS Type” in the “Wireless Settings” → “RADIUS” → “RADIUS Settings” menu.

 **To use RADIUS servers, go to “Wireless Settings” → “Security” and select “MAC RADIUS Authentication” → “Additional Authentication” and select “MAC RADIUS Authentication” (see IV-3-1-3. & IV-3-2-3).**

Internal Server	
Internal Server	<input type="checkbox"/> Enable
EAP Internal Authentication	PEAP(MS-PEAP) ▼
EAP Certificate File Format	PKCS#12(*.pfx/*.p12)
EAP Certificate File	<input type="button" value="Upload"/>
Shared Secret	<input type="text"/>
Session-Timeout	3600 second(s)
Termination-Action	<input checked="" type="radio"/> Reauthentication (RADIUS-Request) <input type="radio"/> Not-Reauthentication (Default) <input type="radio"/> Not-Send

<b>Internal Server</b>	Check/uncheck to enable/disable the access point’s internal RADIUS server.
<b>EAP Internal Authentication</b>	Select EAP internal authentication type from the drop down menu.
<b>EAP Certificate File Format</b>	Displays the EAP certificate file format: PCK#12(*.pfx/*.p12)
<b>EAP Certificate File</b>	Click “Upload” to open a new window and select the location of an EAP certificate file to



	use. If no certificate file is uploaded, the internal RADIUS server will use a self-made certificate.
<b>Shared Secret</b>	Enter a shared secret/password for use between the internal RADIUS server and RADIUS client. The shared secret should be 1 – 99 characters in length. This should match the “MAC-RADIUS” password used in <b>IV-3-1-3-6</b> or <b>IV-3-2-3</b> .
<b>Session Timeout</b>	Set a duration of session timeout in seconds between 0 – 86400.
<b>Termination Action</b>	Select a termination-action attribute: “Reauthentication” sends a RADIUS request to the access point, “Not-Reauthentication” sends a default termination-action attribute to the access point, “Not-Send” no termination-action attribute is sent to the access point.

### IV-3-4-3. RADIUS Accounts

#### > Radius Accounts

The internal RADIUS server can authenticate up to 256 user accounts. The “RADIUS Accounts” page allows you to configure and manage users.

**RADIUS Accounts**

**User Name**

Example: USER1, USER2, USER3, USER4

Add
Reset

**User Registration List**

Select	User Name	Password	Customize
<input type="checkbox"/>	EDIMAX	Not Configured	<div style="border: 1px solid #ccc; padding: 2px; display: inline-block;">Edit</div>

Delete Selected

Delete All

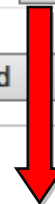

**Edit User Registration List**

**User Name**

EDIMAX

(4-16characters)

**Password**

(6-32characters)

<b>User Name</b>	Enter the user names here, separated by commas.
<b>Add</b>	Click “Add” to add the user to the user registration list.

<b>Reset</b>	Clear text from the user name box.
--------------	------------------------------------

<b>Select</b>	Check the box to select a user.
<b>User Name</b>	Displays the user name.
<b>Password</b>	Displays if specified user name has a password (configured) or not (not configured).
<b>Customize</b>	Click "Edit" to open a new field to set/edit a password for the specified user name (below).

<b>Delete Selected</b>	Delete selected user from the user registration list.
<b>Delete All</b>	Delete all users from the user registration list.

### Edit User Registration List

<b>User Name</b>	Existing user name is displayed here and can be edited according to your preference.
<b>Password</b>	Enter or edit a password for the specified user.

### IV-3-5. MAC Filter

#### > MAC Filter

Mac filtering is a security feature that can help to prevent unauthorized users from connecting to your access point.

This function allows you to define a list of network devices permitted to connect to the access point. Devices are each identified by their unique MAC address. If a device which is not on the list of permitted MAC addresses attempts to connect to the access point, it will be denied.



**To enable MAC filtering, go to “Wireless Settings” → “2.4GHz 11bgn/5GHz 11ac 11an” → “Security” → “Additional Authentication” and select “MAC Filter” (see IV-3-1-3. & IV-3-2-3).**

The MAC address filtering table is displayed below:

#### Add MAC Addresses

Add Reset

---

#### MAC Address Filtering Table

Select	MAC Address
<input type="checkbox"/>	FC:F8:AE:43:43:7E

Delete Selected Delete All Export

<b>Add MAC Address</b>	Enter a MAC address of computer or network device manually e.g. 'aa-bb-cc-dd-ee-ff' or enter multiple MAC addresses separated with
------------------------	--

	commas, e.g. 'aa-bb-cc-dd-ee-ff,aa-bb-cc-dd-ee-gg'
<b>Add</b>	Click "Add" to add the MAC address to the MAC address filtering table.
<b>Reset</b>	Clear all fields.

MAC address entries will be listed in the "MAC Address Filtering Table". Select an entry using the "Select" checkbox.

<b>Select</b>	Delete selected or all entries from the table.
<b>MAC Address</b>	The MAC address is listed here.
<b>Delete Selected</b>	Delete the selected MAC address from the list.
<b>Delete All</b>	Delete all entries from the MAC address filtering table.
<b>Export</b>	Click "Export" to save a copy of the MAC filtering table. A new window will pop up for you to select a location to save the file.

## IV-3-6. WMM

### > WMM

Wi-Fi Multimedia (WMM) is a Wi-Fi Alliance interoperability certification based on the IEEE 802.11e standard, which provides

Quality of Service (QoS) features to IEEE 802.11 networks. WMM prioritizes traffic according to four categories: background, best effort, video and voice.

WMM-EDCA Settings				
WMM Parameters of Access Point				
	CWMin	CWMax	AIFSN	TxOP
Back Ground	4	10	7	0
Best Effort	4	6	3	0
Video	3	4	1	94
Voice	2	3	1	47

WMM Parameters of Station				
	CWMin	CWMax	AIFSN	TxOP
Back Ground	4	10	7	0
Best Effort	4	10	3	0
Video	3	4	2	94
Voice	2	3	2	47

Configuring WMM consists of adjusting parameters on queues for different categories of wireless traffic. Traffic is sent to the following queues:

<b>Background</b>	Low Priority	High throughput, non time sensitive bulk data e.g. FTP
<b>Best Effort</b>	Medium Priority	Traditional IP data, medium throughput and delay.
<b>Video</b>	High Priority	Time sensitive video data with minimum time delay.
<b>Voice</b>	High Priority	Time sensitive data such as VoIP and streaming media with minimum time delay.

Queues automatically provide minimum transmission delays for video, voice, multimedia and critical applications. The values can further be adjusted manually:

<b>CWMin</b>	Minimum Contention Window (milliseconds): This value is input to the initial random backoff wait time algorithm for retry of a data frame transmission. The backoff wait time will be generated between 0 and this value. If the frame is not sent, the random backoff value is doubled until the value reaches the number defined by CWMax (below). The CWMin value must be lower than the CWMax value. The contention window scheme helps to avoid frame collisions and determine priority of frame transmission. A shorter window has a higher probability (priority) of transmission.
<b>CWMax</b>	Maximum Contention Window (milliseconds): This value is the upper limit to random backoff value doubling (see above).
<b>AIFSN</b>	Arbitration Inter-Frame Space (milliseconds): Specifies additional time between when a channel goes idle and the AP/client sends data frames. Traffic with a lower AIFSN value has a higher priority.
<b>TxOP</b>	Transmission Opportunity (milliseconds): The maximum interval of time an AP/client can transmit. This makes channel access more efficiently prioritized. A value of 0 means only one frame per transmission. A greater value effects higher priority.

## IV-4. Management

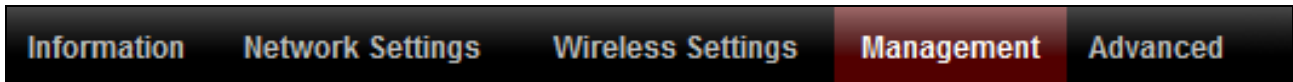

***Screenshots displayed are examples. The information shown on your screen will vary depending on your configuration.***

### IV-4-1. Admin



You can change the password used to login to the browser-based configuration interface here.

It is advised to do so for security purposes.



***If you change the administrator password, please make a note of the new password. In the event that you forget this password and are unable to login to the browser based configuration interface, see I-5. Reset for how to reset the access point.***



Account to Manage This Device	
Administrator Name	<input type="text" value="admin"/>
Administrator Password	<input type="password" value="•••••"/> (4-32 Characters)
	<input type="password" value="•••••"/> (Confirm)
<input type="button" value="Apply"/>	

Advanced Settings	
Product Name	<input type="text" value="AP801F02F1968A"/>
Management Protocol	<input checked="" type="checkbox"/> HTTP <input checked="" type="checkbox"/> HTTPS <input checked="" type="checkbox"/> TELNET <input type="checkbox"/> SSH <input type="checkbox"/> SNMP
SNMP Version	<input type="text" value="v1/v2c"/> ▾
SNMP Get Community	<input type="text" value="public"/>
SNMP Set Community	<input type="text" value="private"/>
SNMP Trap	<input type="text" value="Disabled"/> ▾
SNMP Trap Community	<input type="text" value="public"/>
SNMP Trap Manager	<input type="text"/>
<input type="button" value="Apply"/>	

Account to Manage This Device	
<b>Administrator Name</b>	Set the access point's administrator name. This is used to log in to the browser based configuration interface and must be between 4-16 alphanumeric characters (case sensitive).
<b>Administrator Password</b>	Set the access point's administrator password. This is used to log in to the browser based configuration interface and must be between 4-32 alphanumeric characters (case sensitive).

Advanced Settings	
<b>Product Name</b>	Edit the product name according to your preference consisting of 1-32 alphanumeric characters. This name is used for reference purposes.

<b>Management Protocol</b>	Check/uncheck the boxes to enable/disable specified management interfaces (see below). When SNMP is enabled, complete the SNMP fields below.
<b>SNMP Version</b>	Select SNMP version appropriate for your SNMP manager.
<b>SNMP Get Community</b>	Enter an SNMP Get Community name for verification with the SNMP manager for SNMP-GET requests.
<b>SNMP Set Community</b>	Enter an SNMP Set Community name for verification with the SNMP manager for SNMP-SET requests.
<b>SNMP Trap</b>	Enable or disable SNMP Trap to notify SNMP manager of network errors.
<b>SNMP Trap Community</b>	Enter an SNMP Trap Community name for verification with the SNMP manager for SNMP-TRAP requests.
<b>SNMP Trap Manager</b>	Specify the IP address or sever name (2-128 alphanumeric characters) of the SNMP manager.

## **HTTP**

*Internet browser HTTP protocol management interface*

## **HTTPS**

*Internet browser HTTPS protocol management interface*

## **TELNET**

*Client terminal with telnet protocol management interface*

## **SSH**

*Client terminal with SSH protocol version 1 or 2 management interface*

## **SNMP**

*Simple Network Management Protocol. SNMPv1, v2 & v3 protocol supported. SNMPv2 can be used with community based authentication. SNMPv3 uses user-based security model (USM) architecture.*

## IV-4-2. Date and Time

### > Date and Time

You can configure the time zone settings of your access point here. The date and time of the device can be configured manually or can be synchronized with a time server.

Date and Time Settings	
Local Time	2012 <input type="text"/> Year Jan <input type="text"/> Month 1 <input type="text"/> Day
	0 <input type="text"/> Hours 00 <input type="text"/> Minutes 00 <input type="text"/> Seconds
Acquire Current Time from Your PC	

NTP Time Server	
Use NTP	<input type="checkbox"/> Enable
Server Name	<input type="text"/>
Update Interval	24 <input type="text"/> (Hours)

Time Zone	
Time Zone	(GMT) Greenwich Mean Time: Dublin, Edinburgh, Lisbon, London <input type="text"/>

Date and Time Settings	
<b>Local Time</b>	Set the access point's date and time manually using the drop down menus.
<b>Acquire Current Time from your PC</b>	Click "Acquire Current Time from Your PC" to enter the required values automatically according to your computer's current time and date.

NTP Time Server	
<b>Use NTP</b>	The access point also supports NTP (Network Time Protocol) for automatic time and date setup.

<b>Server Name</b>	Enter the host name or IP address of the time server if you wish.
<b>Update Interval</b>	Specify a frequency (in hours) for the access point to update/synchronize with the NTP server.

<b>Time Zone</b>	
<b>Time Zone</b>	Select the time zone of your country/ region. If your country/region is not listed, please select another country/region whose time zone is the same as yours.

### IV-4-3. Syslog Server

#### > Syslog Server

The system log can be sent to a server.

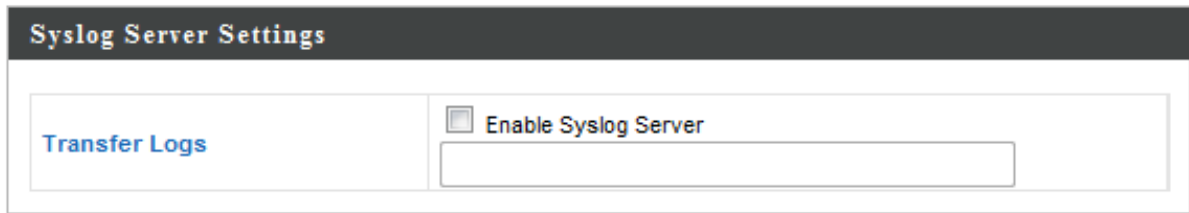

The screenshot shows a configuration window titled "Syslog Server Settings". On the left, there is a blue link labeled "Transfer Logs". On the right, there is a checkbox labeled "Enable Syslog Server" which is currently unchecked. Below the checkbox is a text input field for entering a host name, domain, or IP address.

<b>Transfer Logs</b>	Check/uncheck the box to enable/disable the use of a syslog server, and enter a host name, domain or IP address for the server, consisting of up to 128 alphanumeric characters.
----------------------	--

#### IV-4-4. I'm Here

##### > I'm Here

The access point features a built-in buzzer which can sound on command using the “I’m Here” page. This is useful for network administrators and engineers working in complex network environments to locate the access point.

**Duration of Sound**

Duration of Sound  (1-300 seconds)

Sound Buzzer

 ***The buzzer is loud!***

<b>Duration of Sound</b>	Set the duration for which the buzzer will sound when the “Sound Buzzer” button is clicked.
<b>Sound Buzzer</b>	Activate the buzzer sound for the above specified duration of time.

## IV-5. Advanced

Information Network Settings Wireless Settings Management **Advanced**



*Screenshots displayed are examples. The information shown on your screen will vary depending on your configuration.*

### IV-5-1. LED Settings

#### > LED Settings

The access point's LEDs can be manually enabled or disabled according to your preference.

LED Settings	
Power LED	<input checked="" type="radio"/> On <input type="radio"/> Off
Diag LED	<input checked="" type="radio"/> On <input type="radio"/> Off

<b>Power LED</b>	Select on or off.
<b>Diag LED</b>	Select on or off.

## IV-5-2. Update Firmware

### > Update Firmware

The “Firmware” page allows you to update the system firmware to a more recent version. Updated firmware versions often offer increased performance and security, as well as bug fixes. You can download the latest firmware from the Edimax website.

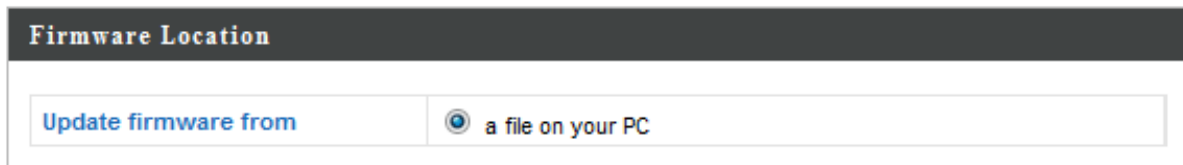

The screenshot shows a section titled "Firmware Location" with a dark header. Below the header is a form with two radio buttons. The first radio button is selected and is labeled "Update firmware from". The second radio button is labeled "a file on your PC".



The screenshot shows a section titled "Update firmware from PC" with a dark header. Below the header is a form with a text input field labeled "Firmware Update File" and a "Browse..." button. Below the input field is an "Update" button.



***Do not switch off or disconnect the access point during a firmware upgrade, as this could damage the device.***

<b>Update Firmware From</b>	Select “a file on your PC” to upload firmware from your local computer.
<b>Firmware Update File</b>	Click “Browse” to open a new window to locate and select the firmware file in your computer.
<b>Update</b>	Click “Update” to upload the specified firmware file to your access point.



### IV-5-3. Save/Restore Settings

**> Save/Restore Settings** The access point’s “Save/Restore Settings” page enables you to save/backup the access point’s current settings as a file to your local computer, and restore the access point to previously saved settings.

Save / Restore Settings	
<b>Using Device</b>	Select “Using your PC” to save the access point’s settings to your local computer.

Save Settings to PC	
<b>Save Settings</b>	Click “Save” to save settings and a new window will open to specify a location to save the settings file. You can also check the “Encrypt the configuration file with a password” box and enter a password to protect the file in the field underneath, if you wish.

## Restore Settings from PC

### **Restore Settings**

Click the browse button to find a previously saved settings file on your computer, then click “Restore” to replace your current settings. If your settings file is encrypted with a password, check the “Open file with password” box and enter the password in the field underneath.

#### IV-5-4. Factory Default

##### > Factory Default

If the access point malfunctions or is not responding, then it is recommended that you reboot the device (see **IV-5.5**) or reset the device back to its factory default settings. You can reset the access point back to its default settings using this feature if the location of the access point is not convenient to access the reset button.

This will restore all settings to factory defaults.

Factory Default

<b>Factory Default</b>	Click “Factory Default” to restore settings to the factory default. A pop-up window will appear and ask you to confirm.
------------------------	---



***After resetting to factory defaults, please wait for the access point to reset and restart.***

## IV-5-5. Reboot

**> Reboot** If the access point malfunctions or is not responding, then it is recommended that you reboot the device or reset the access point back to its factory default settings (see **IV-5-4**). You can reboot the access point remotely using this feature.

This will reboot the product. Your settings will not be changed. Click "Reboot" to reboot the product now.

Reboot

<b>Reboot</b>	Click "Reboot" to reboot the device. A countdown will indicate the progress of the reboot.
---------------	--

## ***V. Appendix***

---

### **V-1. Configuring your IP address**

The access point uses the default IP address **192.168.2.2**. In order to access the browser based configuration interface, you need to modify the IP address of your computer to be in the same IP address subnet e.g. **192.168.2.x (x = 3 – 254)**.

The procedure for modifying your IP address varies across different operating systems; please follow the guide appropriate for your operating system.

In the following examples we use the IP address **192.168.2.10** though you can use any IP address in the range **192.168.2.x (x = 3 – 254)**.

## V-1-1. Windows XP

1. Click the “Start” button (it should be located in the lower-left corner of your computer), then click “Control Panel”. Double-click the “Network and Internet Connections” icon, click “Network Connections”, and then double-click “Local Area Connection”. The “Local Area Connection Status” window will then appear, click “Properties”.

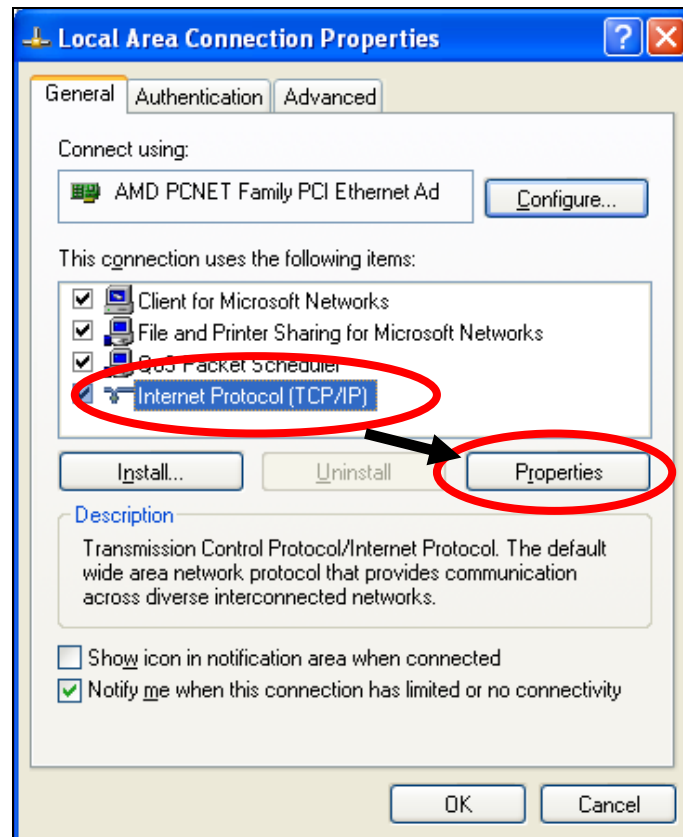

2. Select “Use the following IP address”, then input the following values:

**IP address:** 192.168.2.10

**Subnet Mask:** 255.255.255.0

Click ‘OK’ when finished.

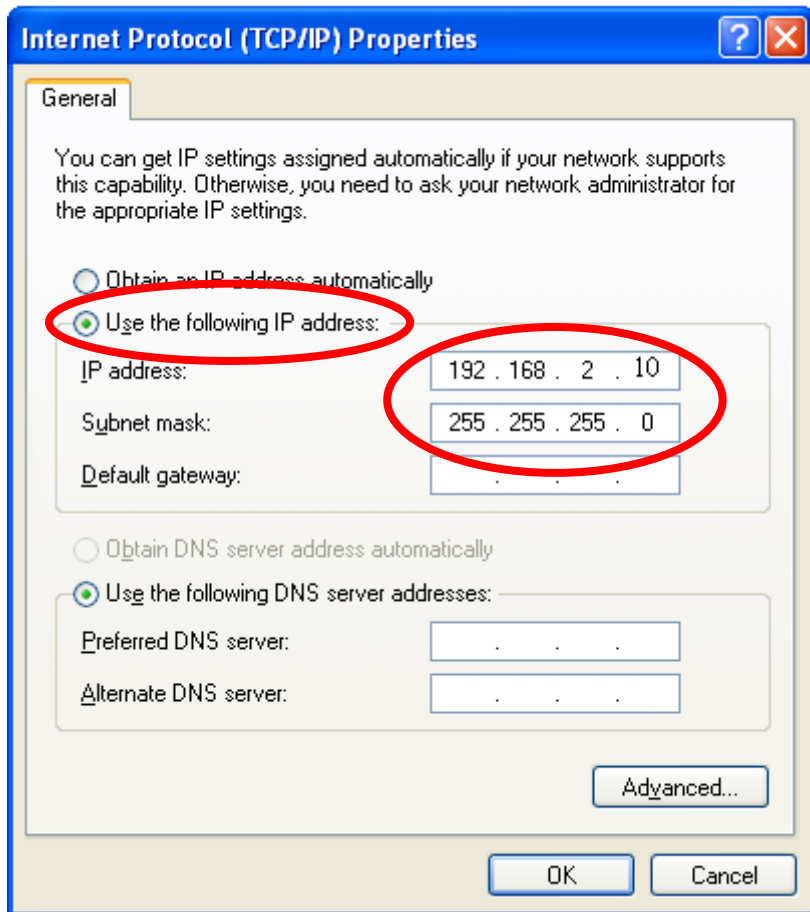

## V-1-2. Windows Vista

1. Click the “Start” button (it should be located in the lower-left corner of your computer), then click “Control Panel”. Click “View Network Status and Tasks”, then click “Manage Network Connections”. Right-click “Local Area Network”, then select “Properties”. The “Local Area Connection Properties” window will then appear, select “Internet Protocol Version 4 (TCP / IPv4)”, and then click “Properties”.

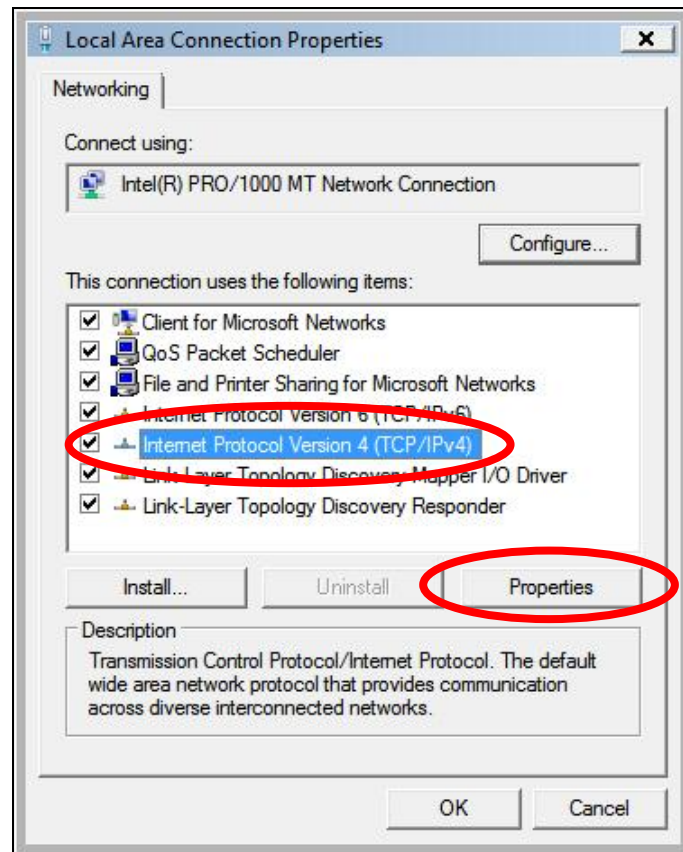

2. Select “Use the following IP address”, then input the following values:

**IP address:** 192.168.2.10

**Subnet Mask:** 255.255.255.0

Click ‘OK’ when finished.



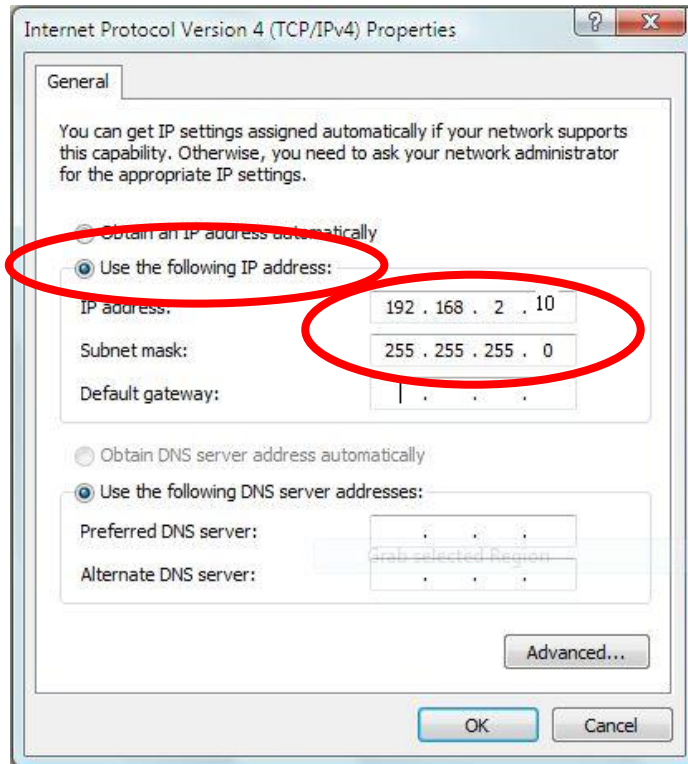

### V-1-3. Windows 7

1. Click the “Start” button (it should be located in the lower-left corner of your computer), then click “Control Panel”.

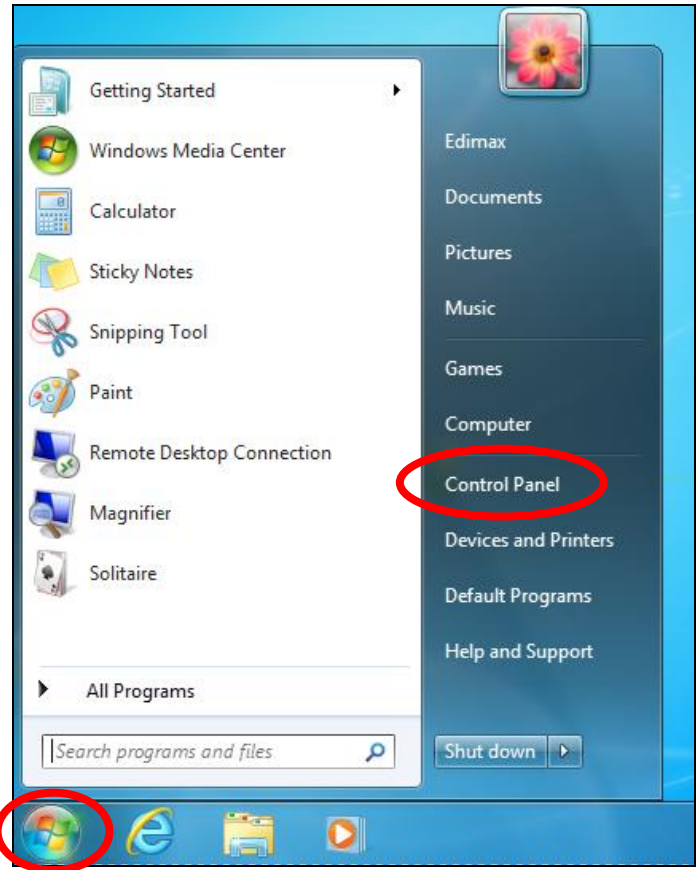

2. Under “Network and Internet” click “View network status and tasks”.

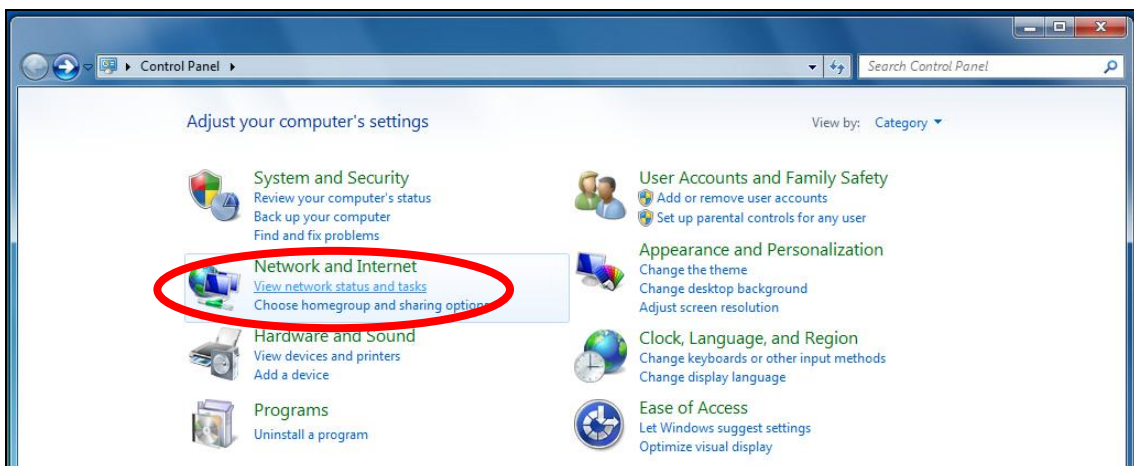

3. Click “Local Area Connection”.

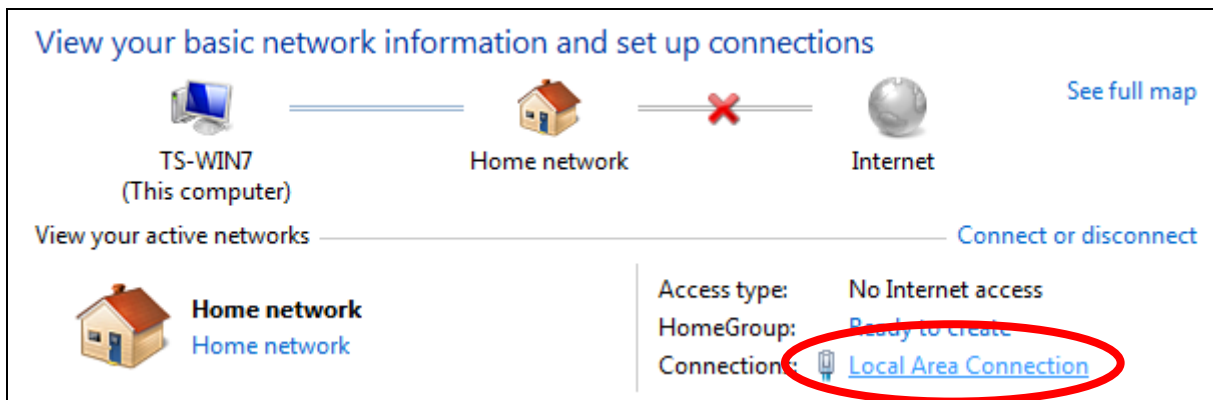

4. Click "Properties".

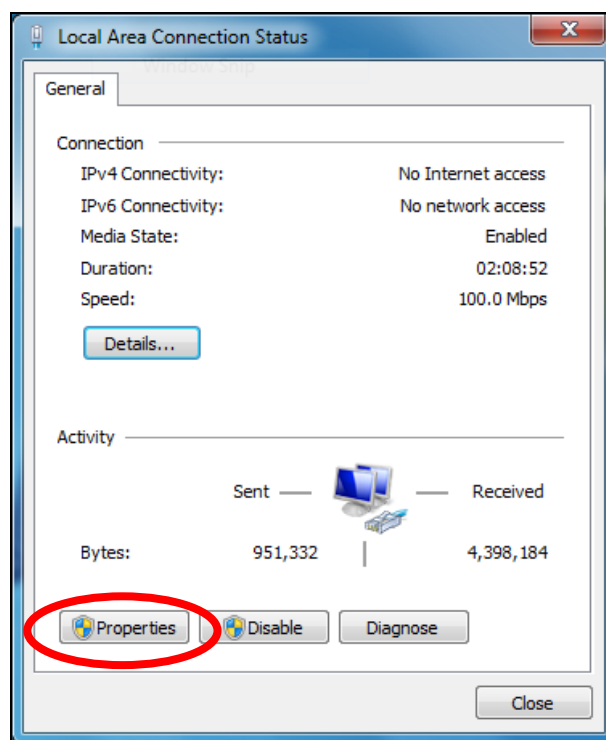

5. Select “Internet Protocol Version 4 (TCP/IPv4)” and then click “Properties”.

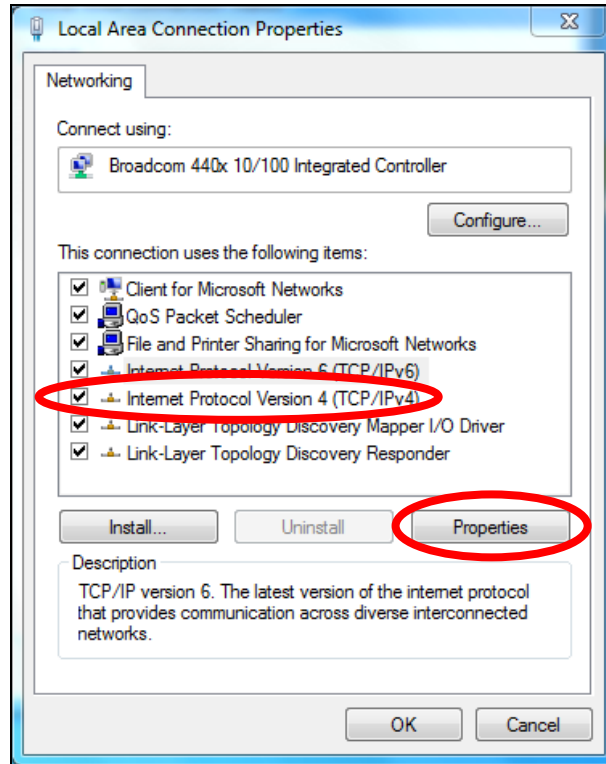

6. Select “Use the following IP address”, then input the following values:

**IP address:** 192.168.2.10

**Subnet Mask:** 255.255.255.0

Click ‘OK’ when finished.

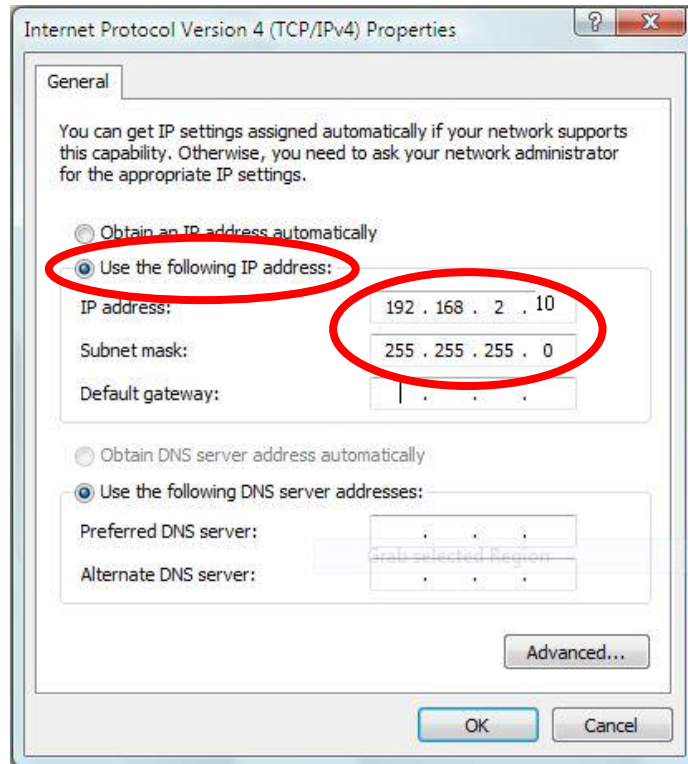

## V-1-4. Windows 8

1. From the Windows 8 Start screen, you need to switch to desktop mode. Move your cursor to the bottom left of the screen and click.

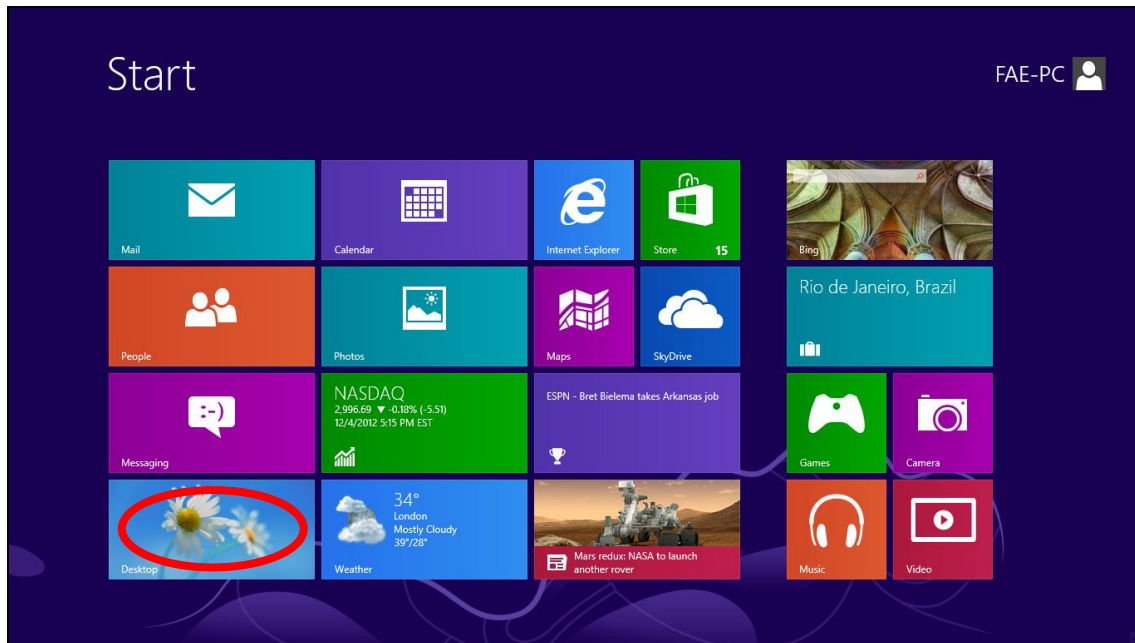

2. In desktop mode, click the File Explorer icon in the bottom left of the screen, as shown below.

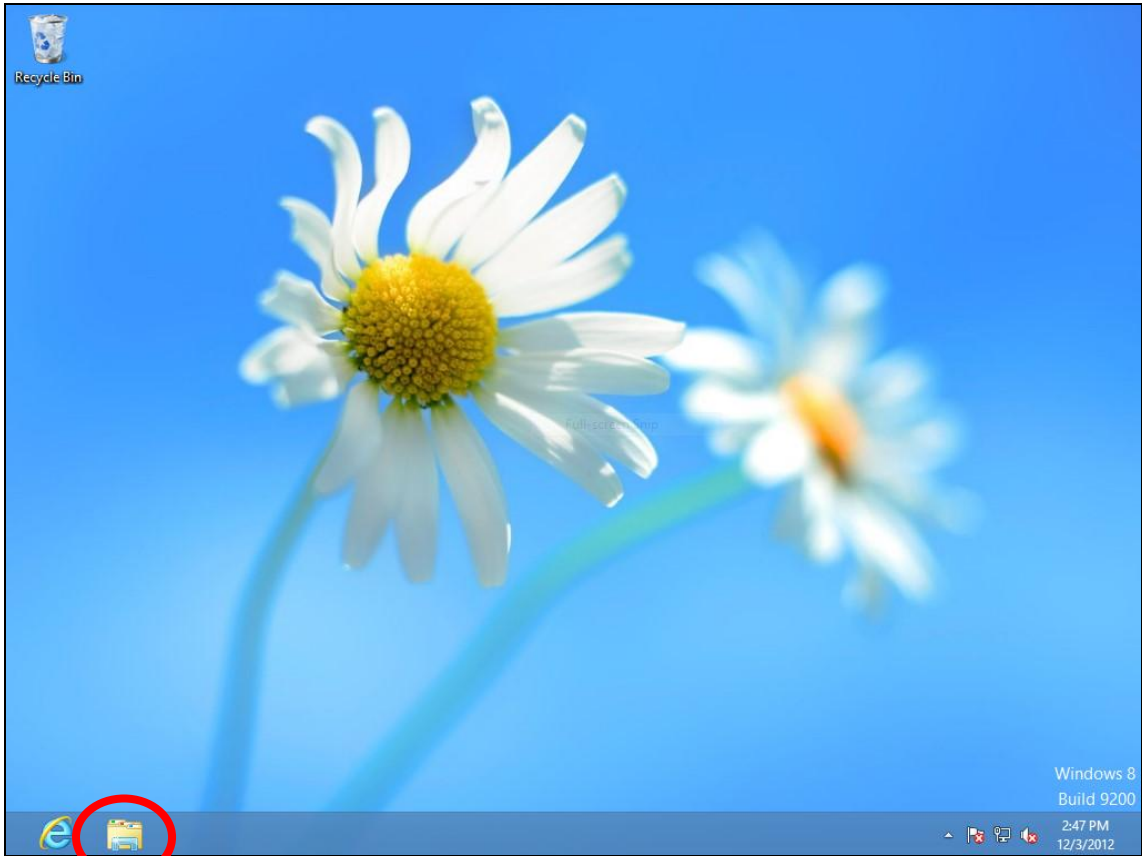

**3.** Right click “Network” and then select “Properties”.

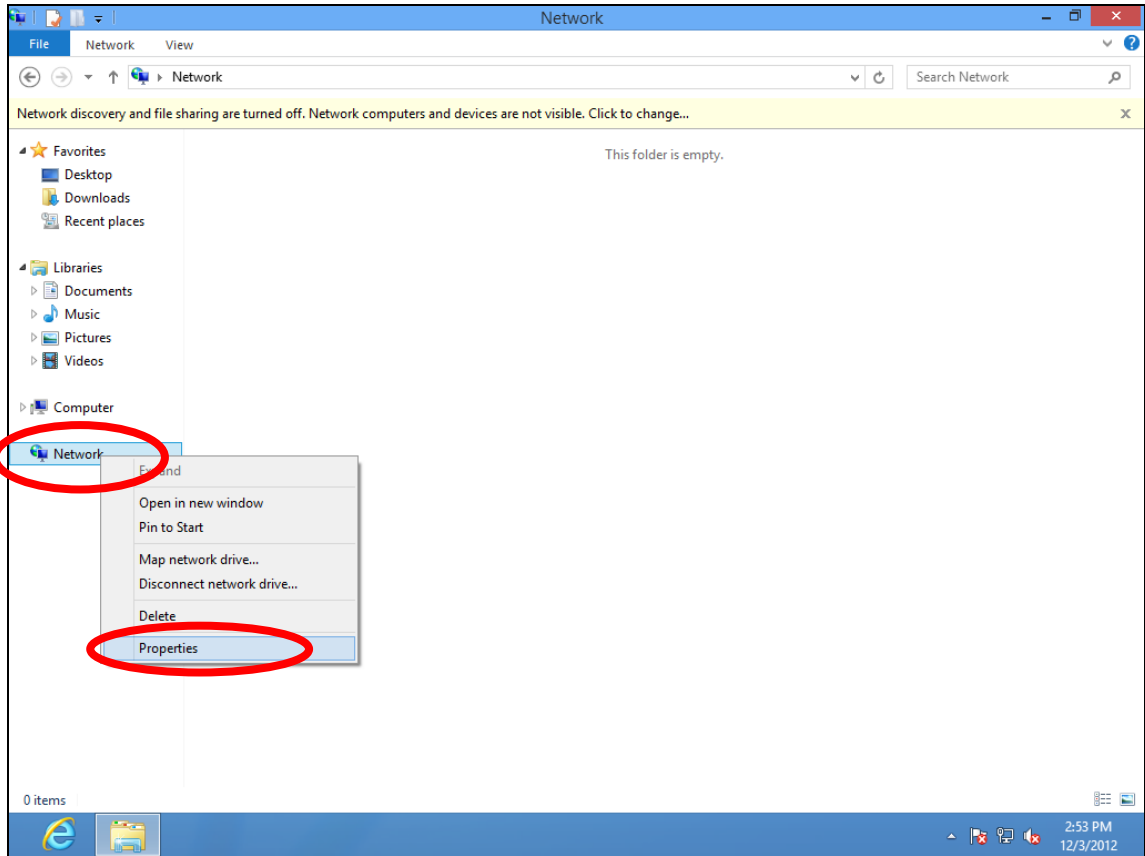

4. In the window that opens, select “Change adapter settings” from the left side.

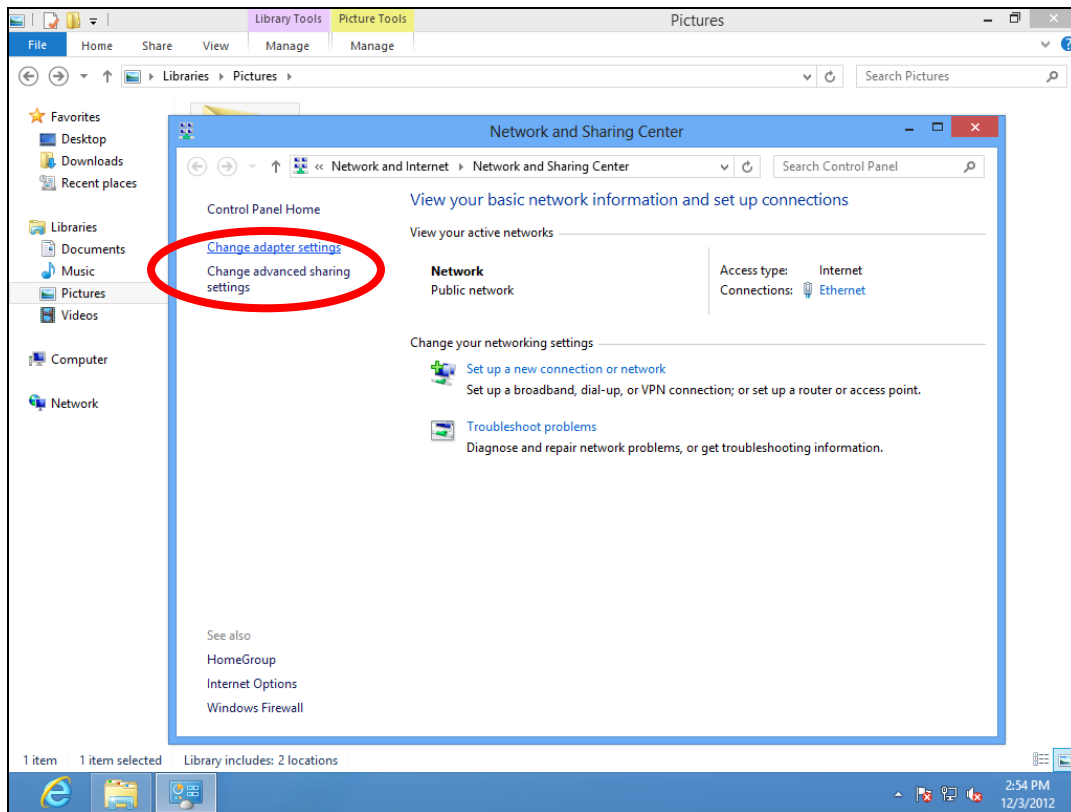

5. Choose your connection and right click, then select “Properties”.

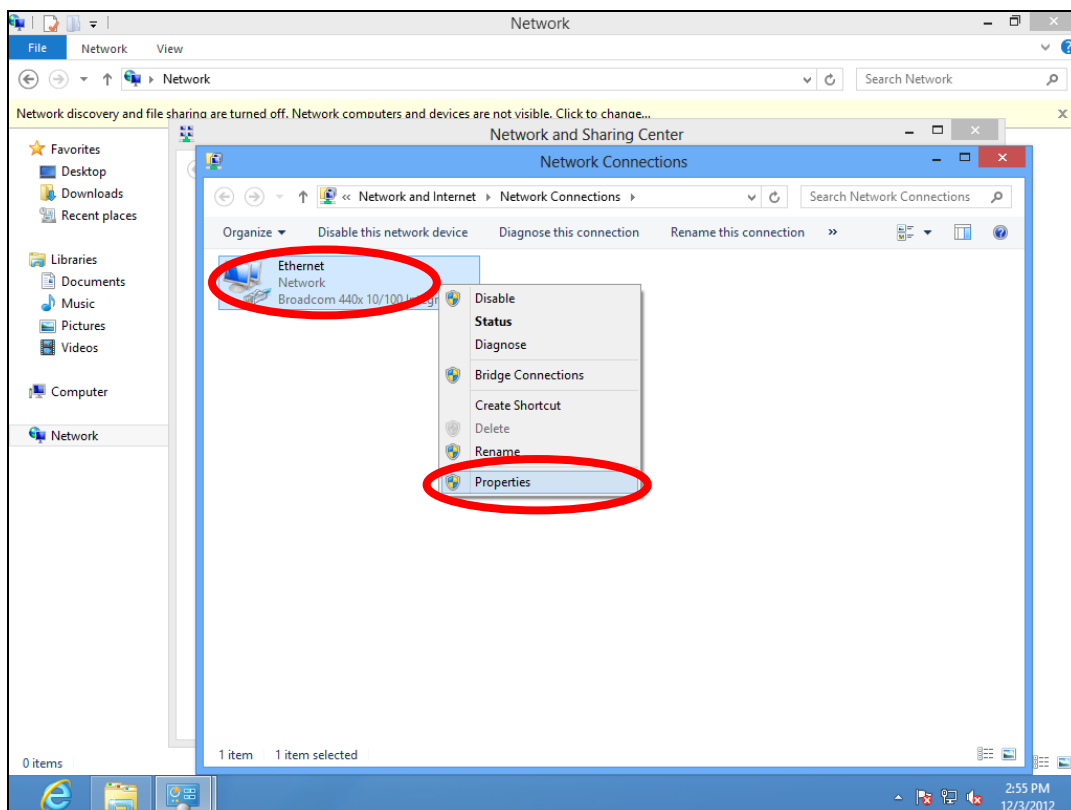



6. Select “Internet Protocol Version 4 (TCP/IPv4) and then click “Properties”.

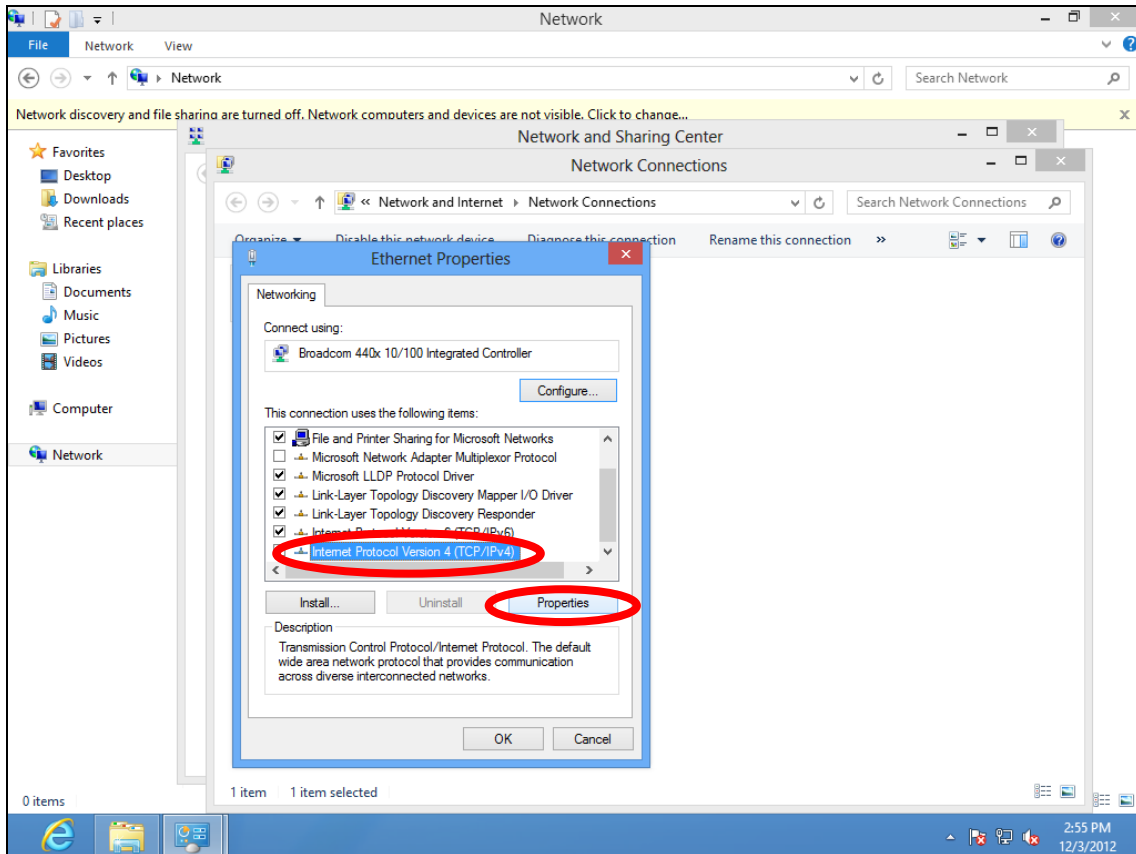

7. Select “Use the following IP address”, then input the following values:

**IP address:** 192.168.2.10

**Subnet Mask:** 255.255.255.0

Click ‘OK’ when finished.

## V-1-5. Mac

1. Have your Macintosh computer operate as usual, and click on “System Preferences”

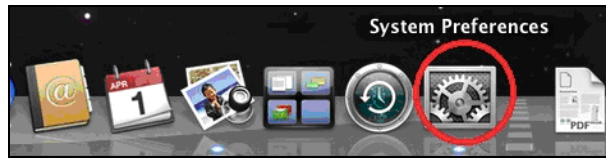

2. In System Preferences, click on “Network”.



3. Click on “Ethernet” in the left panel.

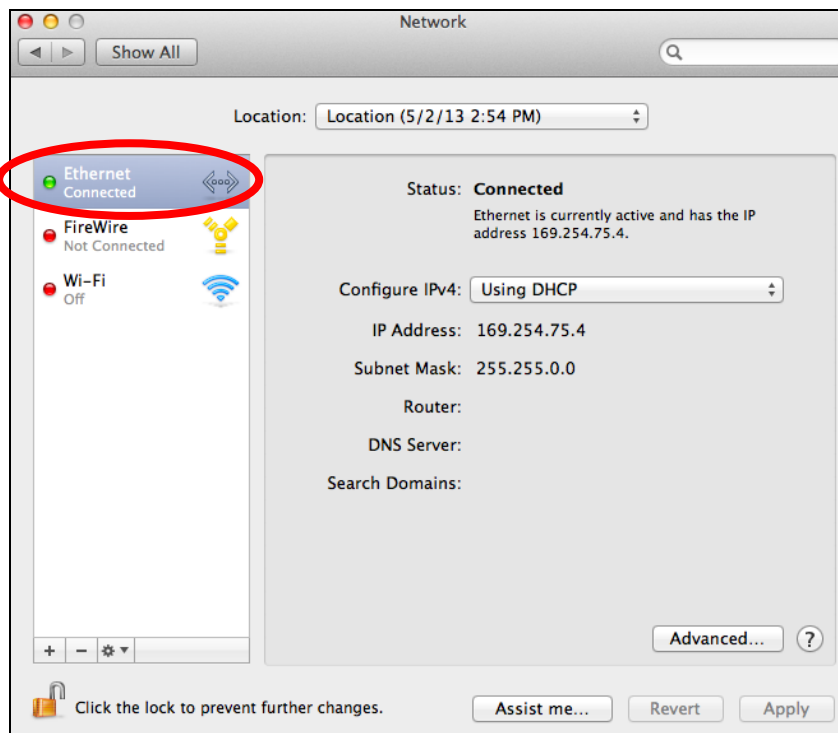

4. Open the drop-down menu labeled “Configure IPv4” and select “Manually”.

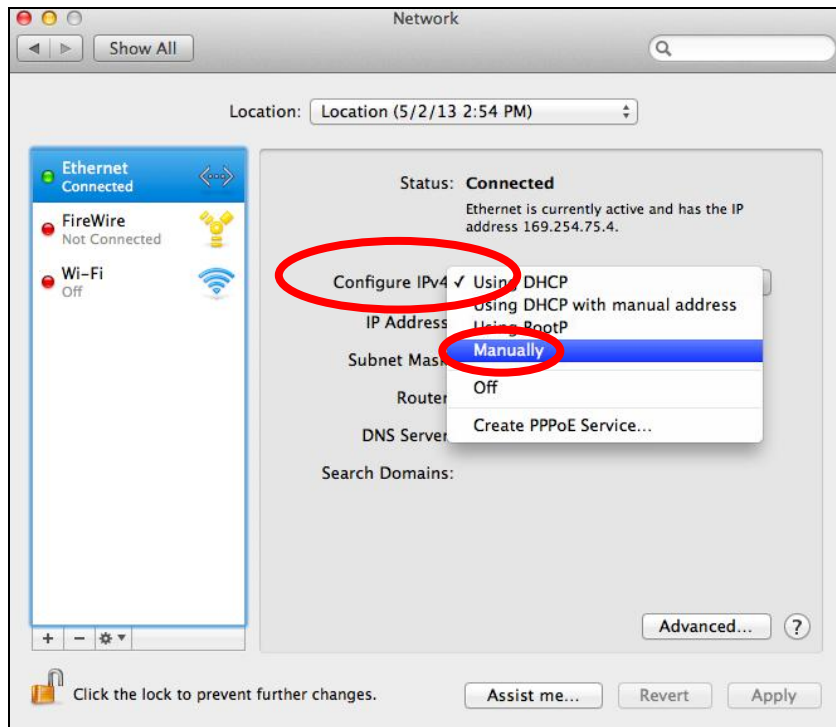

5. Enter the IP address 192.168.2.10 and subnet mask 255.255.255.0. Click on “Apply” to save the changes.

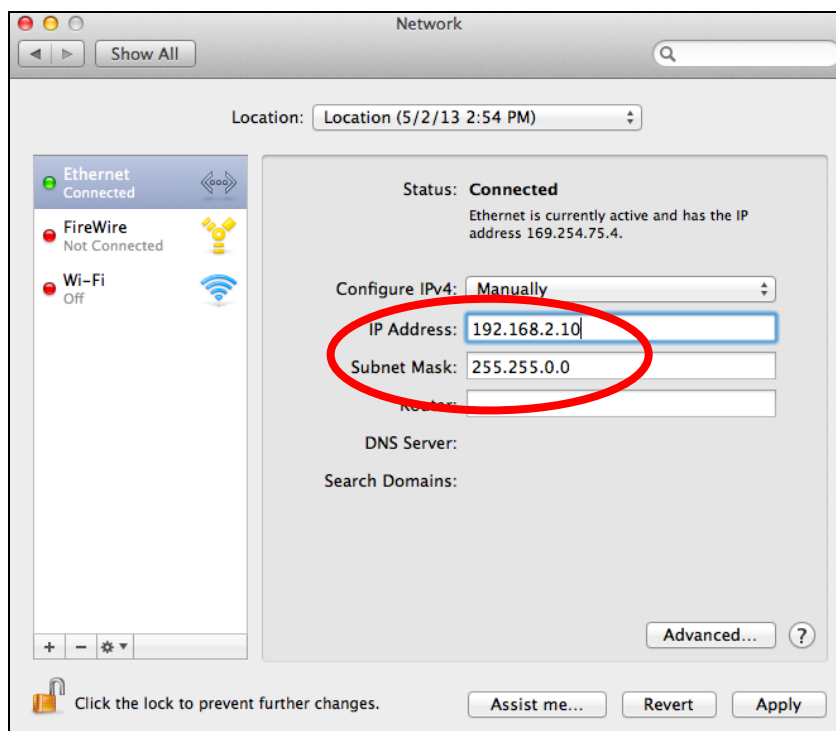

## V-1-6. Glossary

**Default Gateway (Access point):** Every non-access point IP device needs to configure a default gateway's IP address. When the device sends out an IP packet, if the destination is not on the same network, the device has to send the packet to its default gateway, which will then send it out towards the destination.

**DHCP:** Dynamic Host Configuration Protocol. This protocol automatically gives every computer on your home network an IP address.

**DNS Server IP Address:** DNS stands for Domain Name System, which allows Internet servers to have a domain name (such as `www.Broadbandaccesspoint.com`) and one or more IP addresses (such as `192.34.45.8`). A DNS server keeps a database of Internet servers and their respective domain names and IP addresses, so that when a domain name is requested (as in typing "`Broadbandaccesspoint.com`" into your Internet browser), the user is sent to the proper IP address. The DNS server IP address used by the computers on your home network is the location of the DNS server your ISP has assigned to you.

**DSL Modem:** DSL stands for Digital Subscriber Line. A DSL modem uses your existing phone lines to transmit data at high speeds.

**Ethernet:** A standard for computer networks. Ethernet networks are connected by special cables and hubs, and move data around at up to 10/100 million bits per second (Mbps).

**IP Address and Network (Subnet) Mask:** IP stands for Internet Protocol. An IP address consists of a series of four numbers separated by periods, that identifies a single, unique Internet computer host in an IP network. Example: `192.168.2.1`. It consists of 2 portions: the IP network address, and the host identifier.

The IP address is a 32-bit binary pattern, which can be represented as four cascaded decimal numbers separated by ".": `aaa.aaa.aaa.aaa`, where each "aaa" can be anything from 000 to 255, or as four cascaded binary numbers separated by ".": `bbbbbbbb.bbbbbbbb.bbbbbbbb.bbbbbbbb`, where each "b" can either be 0 or 1.

A network mask is also a 32-bit binary pattern, and consists of consecutive leading 1's followed by consecutive trailing 0's, such as 11111111.11111111.11111111.00000000. Therefore sometimes a network mask can also be described simply as "x" number of leading 1's. When both are represented side by side in their binary forms, all bits in the IP address that correspond to 1's in the network mask become part of the IP network address, and the remaining bits correspond to the host ID.

For example, if the IP address for a device is, in its binary form, 11011001.10110000.10010000.00000111, and if its network mask is, 11111111.11111111.11110000.00000000 It means the device's network address is 11011001.10110000.10010000.00000000, and its host ID is, 00000000.00000000.00000000.00000111. This is a convenient and efficient method for access points to route IP packets to their destination.

**ISP Gateway Address:** (see ISP for definition). The ISP Gateway Address is an IP address for the Internet access point located at the ISP's office.

**ISP:** Internet Service Provider. An ISP is a business that provides connectivity to the Internet for individuals and other businesses or organizations.

**LAN:** Local Area Network. A LAN is a group of computers and devices connected together in a relatively small area (such as a house or an office). Your home network is considered a LAN.

**MAC Address:** MAC stands for Media Access Control. A MAC address is the hardware address of a device connected to a network. The MAC address is a unique identifier for a device with an Ethernet interface. It is comprised of two parts: 3 bytes of data that corresponds to the Manufacturer ID (unique for each manufacturer), plus 3 bytes that are often used as the product's serial number.

**NAT:** Network Address Translation. This process allows all of the computers on your home network to use one IP address. Using the broadband access point's NAT capability, you can access the Internet from any computer on your home network without having to purchase more IP addresses from your ISP.

**Port:** Network Clients (LAN PC) uses port numbers to distinguish one network application/protocol over another. Below is a list of common applications and protocol/port numbers:

Application	Protocol	Port Number
Telnet	TCP	23
FTP	TCP	21
SMTP	TCP	25
POP3	TCP	110
H.323	TCP	1720
SNMP	UCP	161
SNMP Trap	UDP	162
HTTP	TCP	80
PPTP	TCP	1723
PC Anywhere	TCP	5631
PC Anywhere	UDP	5632

**Access point:** A access point is an intelligent network device that forwards packets between different networks based on network layer address information such as IP addresses.

**Subnet Mask:** A subnet mask, which may be a part of the TCP/IP information provided by your ISP, is a set of four numbers (e.g. 255.255.255.0) configured like an IP address. It is used to create IP address numbers used only within a particular network (as opposed to valid IP address numbers recognized by the Internet, which must be assigned by InterNIC).

**TCP/IP, UDP:** Transmission Control Protocol/Internet Protocol (TCP/IP) and Unreliable Datagram Protocol (UDP). TCP/IP is the standard protocol for data transmission over the Internet. Both TCP and UDP are transport layer protocol. TCP performs proper error detection and error recovery, and thus is reliable. UDP on the other hand is not reliable. They both run on top of the IP (Internet Protocol), a network layer protocol.

**WAN:** Wide Area Network. A network that connects computers located in geographically separate areas (e.g. different buildings, cities, countries). The Internet is a wide area network.

**Web-based management Graphical User Interface (GUI):** Many devices support a graphical user interface that is based on the web browser. This means the user can use the familiar Netscape or Microsoft Internet Explorer to Control/configure or monitor the device being managed.

## COPYRIGHT

Copyright © Edimax Technology Co., Ltd. all rights reserved. No part of this publication may be reproduced, transmitted, transcribed, stored in a retrieval system, or translated into any language or computer language, in any form or by any means, electronic, mechanical, magnetic, optical, chemical, manual or otherwise, without the prior written permission from Edimax Technology Co., Ltd.

Edimax Technology Co., Ltd. makes no representations or warranties, either expressed or implied, with respect to the contents hereof and specifically disclaims any warranties, merchantability, or fitness for any particular purpose. Any software described in this manual is sold or licensed as is. Should the programs prove defective following their purchase, the buyer (and not this company, its distributor, or its dealer) assumes the entire cost of all necessary servicing, repair, and any incidental or consequential damages resulting from any defect in the software. Edimax Technology Co., Ltd. reserves the right to revise this publication and to make changes from time to time in the contents hereof without the obligation to notify any person of such revision or changes.

The product you have purchased and the setup screen may appear slightly different from those shown in this QIG. The software and specifications are subject to change without notice. Please visit our website [www.edimax.com](http://www.edimax.com) for updates. All brand and product names mentioned in this manual are trademarks and/or registered trademarks of their respective holders.

## Federal Communication Commission Interference Statement

This equipment has been tested and found to comply with the limits for a Class B digital device, pursuant to Part 15 of FCC Rules. These limits are designed to provide reasonable protection against harmful interference in a residential installation. This equipment generates, uses, and can radiate radio frequency energy and, if not installed and used in accordance with the instructions, may cause harmful interference to radio communications. However, there is no guarantee that interference will not occur in a particular installation. If this equipment does cause harmful interference to radio or television reception, which can be determined by turning the equipment off and on, the user is encouraged to try to correct the interference by one or more of the following measures:

1. Reorient or relocate the receiving antenna.
2. Increase the separation between the equipment and receiver.
3. Connect the equipment into an outlet on a circuit different from that to which the receiver is connected.
4. Consult the dealer or an experienced radio technician for help.

### FCC Caution

This device and its antenna must not be co-located or operating in conjunction with any other antenna or transmitter. This device complies with Part 15 of the FCC Rules. Operation is subject to the following two conditions: (1) this device may not cause harmful interference, and (2) this device must accept any interference received, including interference that may cause undesired operation. Any changes or modifications not expressly approved by the party responsible for compliance could void the authority to operate equipment.

### Federal Communications Commission (FCC) Radiation Exposure Statement

This equipment complies with FCC radiation exposure set forth for an uncontrolled environment. In order to avoid the possibility of exceeding the FCC radio frequency exposure limits, human proximity to the antenna shall not be less than 2.5cm (1 inch) during normal operation.

### Federal Communications Commission (FCC) RF Exposure Requirements

SAR compliance has been established in the laptop computer(s) configurations with PCMCIA slot on the side near the center, as tested in the application for certification, and can be used in laptop computer(s) with substantially similar physical dimensions, construction, and electrical and RF characteristics. Use in other devices such as PDAs or lap pads is not authorized. This transmitter is restricted for use with the specific antenna tested in the application for certification. The antenna(s) used for this transmitter must not be co-located or operating in conjunction with any other antenna or transmitter.

### R&TTE Compliance Statement

This equipment complies with all the requirements of DIRECTIVE 1999/5/EC OF THE EUROPEAN PARLIAMENT AND THE COUNCIL of March 9, 1999 on radio equipment and telecommunication terminal equipment and the mutual recognition of their conformity (R&TTE). The R&TTE Directive repeals and replaces in the directive 98/13/EEC (Telecommunications Terminal Equipment and Satellite Earth Station Equipment) As of April 8, 2000.

### Safety

This equipment is designed with the utmost care for the safety of those who install and use it. However, special attention must be paid to the dangers of electric shock and static electricity when working with electrical equipment. All guidelines of this and of the computer manufacture must therefore be allowed at all times to ensure the safe use of the equipment.

### EU Countries Intended for Use

The ETSI version of this device is intended for home and office use in Austria, Belgium, Bulgaria, Cyprus, Czech, Denmark, Estonia, Finland, France, Germany, Greece, Hungary, Ireland, Italy, Latvia, Lithuania, Luxembourg, Malta, Netherlands, Poland, Portugal, Romania, Slovakia, Slovenia, Spain, Sweden, Turkey, and United Kingdom. The ETSI version of this device is also authorized for use in EFTA member states: Iceland, Liechtenstein, Norway, and Switzerland.

### EU Countries Not Intended for Use

None



## EU Declaration of Conformity

- English:** This equipment is in compliance with the essential requirements and other relevant provisions of Directive 2014/53/EU, 2014/35/EU.
- Français:** Cet équipement est conforme aux exigences essentielles et autres dispositions de la directive 2014/53/EU, 2014/35/EU.
- Čeština:** Toto zařízení je v souladu se základními požadavky a ostatními příslušnými ustanoveními směrnic 2014/53/EU, 2014/35/EU.
- Polski:** Urządzenie jest zgodne z ogólnymi wymaganiami oraz szczególnymi warunkami określonymi Dyrektywą UE 2014/53/EU, 2014/35/EU.
- Română:** Acest echipament este în conformitate cu cerințele esențiale și alte prevederi relevante ale Directivei 2014/53/UE, 2014/35/UE.
- Русский:** Это оборудование соответствует основным требованиям и положениям Директивы 2014/53/EU, 2014/35/EU.
- Magyar:** Ez a berendezés megfelel az alapvető követelményeknek és más vonatkozó irányelveknek (2014/53/EU, 2014/35/EU).
- Türkçe:** Bu cihaz 2014/53/EU, 2014/35/EU direktifleri zorunlu istekler ve diğer hükümlerle ile uyumludur.
- Українська:** Обладнання відповідає вимогам і умовам директиви 2014/53/EU, 2014/35/EU.
- Slovenčina:** Toto zariadenie spĺňa základné požiadavky a ďalšie príslušné ustanovenia smerníc 2014/53/EU, 2014/35/EU.
- Deutsch:** Dieses Gerät erfüllt die Voraussetzungen gemäß den Richtlinien 2014/53/EU, 2014/35/EU.
- Español:** El presente equipo cumple los requisitos esenciales de la Directiva 2014/53/EU, 2014/35/EU.
- Italiano:** Questo apparecchio è conforme ai requisiti essenziali e alle altre disposizioni applicabili della Direttiva 2014/53/EU, 2014/35/UE.
- Nederlands:** Dit apparaat voldoet aan de essentiële eisen en andere van toepassing zijnde bepalingen van richtlijn 2014/53/EU, 2014/35/EU.
- Português:** Este equipamento cumpre os requisitos essenciais da Directiva 2014/53/EU, 2014/35/EU.
- Norsk:** Dette utstyret er i samsvar med de viktigste kravene og andre relevante regler i Direktiv 2014/53/EU, 2014/35/EU.
- Svenska:** Denna utrustning är i överensstämmelse med de väsentliga kraven och övriga relevanta bestämmelser i direktiv 2014/53/EU, 2014/35/EU.
- Dansk:** Dette udstyr er i overensstemmelse med de væsentligste krav og andre relevante forordninger i direktiv 2014/53/EU, 2014/35/EU.
- suomen kieli:** Tämä laite täyttää direktiivien 2014/53/EU, 2014/35/EU. oleelliset vaatimukset ja muut asiaankuuluvat määräykset.

FOR USE IN 



### WEEE Directive & Product Disposal



At the end of its serviceable life, this product should not be treated as household or general waste. It should be handed over to the applicable collection point for the recycling of electrical and electronic equipment, or returned to the supplier for disposal.

## Declaration of Conformity

We, Edimax Technology Co., Ltd., declare under our sole responsibility, that the equipment described below complies with the requirements of the European Radio Equipment directives.

**Equipment: AC1200 Dual Band Concurrent Ceiling-Mount AP**  
**Model No.: CAP1200**

The following European standards for essential requirements have been followed:

### Directives 2014/53/EU

Spectrum : EN 300 328 V2.1.1 (2016-11)  
EN 301 893 V2.1.1 (2017-05)  
EMC : Draft EN 301 489-1 V2.2.0 (2017-03), Class B  
Draft EN 301 489-17 V3.2.0 (2017-03)  
EMF : EN 62311:2008  
Safety (LVD) : IEC 62368-1:2014 (2<sup>nd</sup> Edition) and/or EN 62368-1:2014+A11:2017

Edimax Technology Europe B.V.  
Fijenhof 2,  
5652 AE Eindhoven,  
The Netherlands

a company of:  
Edimax Technology Co., Ltd.  
No. 278, Xinhua 1st Rd.,  
Neihu Dist., Taipei City,  
Taiwan

Printed Name: David Huang  
Title: Director  
Edimax Technology Europe B.V.

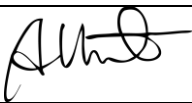

Date of Signature: Nov., 2020  
Signature:   
Printed Name: Albert Chang  
Title: Director  
Edimax Technology Co., Ltd.

## Notice According to GNU General Public License Version 2

This product includes software that is subject to the GNU General Public License version 2. The program is free software and distributed without any warranty of the author. We offer, valid for at least three years, to give you, for a charge no more than the costs of physically performing source distribution, a complete machine-readable copy of the corresponding source code.

Das Produkt beinhaltet Software, die den Bedingungen der GNU/GPL-Version 2 unterliegt. Das Programm ist eine sog. „Free Software“, der Autor stellt das Programm ohne irgendeine Gewährleistungen zur Verfügung. Wir bieten Ihnen für einen Zeitraum von drei Jahren an, eine vollständige maschinenlesbare Kopie des Quelltextes der Programme zur Verfügung zu stellen – zu nicht höheren Kosten als denen, die durch den physikalischen Kopiervorgang anfallen.

### GNU GENERAL PUBLIC LICENSE Version 2, June 1991

Copyright (C) 1989, 1991 Free Software Foundation, Inc. 51 Franklin Street, Fifth Floor, Boston, MA 02110-1301, USA  
Everyone is permitted to copy and distribute verbatim copies of this license document, but changing it is not allowed.

#### Preamble

The licenses for most software are designed to take away your freedom to share and change it. By contrast, the GNU General Public License is intended to guarantee your freedom to share and change free software--to make sure the software is free for all its users. This General Public License applies to most of the Free Software Foundation's software and to any other program whose authors commit to using it. (Some other Free Software Foundation software is covered by the GNU Lesser General Public License instead.) You can apply it to your programs, too.

When we speak of free software, we are referring to freedom, not price. Our General Public Licenses are designed to make sure that you have the freedom to distribute copies of free software (and charge for this service if you wish), that you receive source code or can get it if you want it, that you can change the software or use pieces of it in new free programs; and that you know you can do these things.

To protect your rights, we need to make restrictions that forbid anyone to deny you these rights or to ask you to surrender the rights. These restrictions translate to certain responsibilities for you if you distribute copies of the software, or if you modify it.

For example, if you distribute copies of such a program, whether gratis or for a fee, you must give the recipients all the rights that you have. You must make sure that they, too, receive or can get the source code. And you must show them these terms so they know their rights.

We protect your rights with two steps: (1) copyright the software, and (2) offer you this license which gives you legal permission to copy, distribute and/or modify the software.

Also, for each author's protection and ours, we want to make certain that everyone understands that there is no warranty for this free software. If the software is modified by someone else and passed on, we want its recipients to know that what they have is not the original, so that any problems introduced by others will not reflect on the original authors' reputations.

Finally, any free program is threatened constantly by software patents. We wish to avoid the danger that redistributors of a free program will individually obtain patent licenses, in effect making the program proprietary. To prevent this, we have made it clear that any patent must be licensed for everyone's free use or not licensed at all.

The precise terms and conditions for copying, distribution and modification follow.

#### TERMS AND CONDITIONS FOR COPYING, DISTRIBUTION AND MODIFICATION

0. This License applies to any program or other work which contains a notice placed by the copyright holder saying it may be distributed under the terms of this General Public License. The "Program", below, refers to any such program or work, and a "work based on the Program" means either the Program or any derivative work under copyright law: that is to say, a work containing the Program or a portion of it, either verbatim or with modifications and/or translated into another language. (Hereinafter, translation is included without limitation in the term "modification".) Each licensee is addressed as "you".

Activities other than copying, distribution and modification are not covered by this License; they are outside its scope. The act of running the Program is not restricted, and the output from the Program is covered only if its contents constitute a work based on the Program (independent of having been made by running the Program). Whether that is true depends on what the Program does.

1. You may copy and distribute verbatim copies of the Program's source code as you receive it, in any medium, provided that you conspicuously and appropriately publish on each copy an appropriate copyright notice and disclaimer of warranty; keep

intact all the notices that refer to this License and to the absence of any warranty; and give any other recipients of the Program a copy of this License along with the Program.

You may charge a fee for the physical act of transferring a copy, and you may at your option offer warranty protection in exchange for a fee.

2. You may modify your copy or copies of the Program or any portion of it, thus forming a work based on the Program, and copy and distribute such modifications or work under the terms of Section 1 above, provided that you also meet all of these conditions:

- a) You must cause the modified files to carry prominent notices stating that you changed the files and the date of any change.
- b) You must cause any work that you distribute or publish, that in whole or in part contains or is derived from the Program or any part thereof, to be licensed as a whole at no charge to all third parties under the terms of this License.
- c) If the modified program normally reads commands interactively when run, you must cause it, when started running for such interactive use in the most ordinary way, to print or display an announcement including an appropriate copyright notice and a notice that there is no warranty (or else, saying that you provide a warranty) and that users may redistribute the program under these conditions, and telling the user how to view a copy of this License. (Exception: if the Program itself is interactive but does not normally print such an announcement, your work based on the Program is not required to print an announcement.)

These requirements apply to the modified work as a whole. If identifiable sections of that work are not derived from the Program, and can be reasonably considered independent and separate works in themselves, then this License, and its terms, do not apply to those sections when you distribute them as separate works. But when you distribute the same sections as part of a whole which is a work based on the Program, the distribution of the whole must be on the terms of this License, whose permissions for other licensees extend to the entire whole, and thus to each and every part regardless of who wrote it.

Thus, it is not the intent of this section to claim rights or contest your rights to work written entirely by you; rather, the intent is to exercise the right to control the distribution of derivative or collective works based on the Program.

In addition, mere aggregation of another work not based on the Program with the Program (or with a work based on the Program) on a volume of a storage or distribution medium does not bring the other work under the scope of this License.

3. You may copy and distribute the Program (or a work based on it, under Section 2) in object code or executable form under the terms of Sections 1 and 2 above provided that you also do one of the following:

- a) Accompany it with the complete corresponding machine-readable source code, which must be distributed under the terms of Sections 1 and 2 above on a medium customarily used for software interchange; or,
- b) Accompany it with a written offer, valid for at least three years, to give any third party, for a charge no more than your cost of physically performing source distribution, a complete machine-readable copy of the corresponding source code, to be distributed under the terms of Sections 1 and 2 above on a medium customarily used for software interchange; or,
- c) Accompany it with the information you received as to the offer to distribute corresponding source code. (This alternative is allowed only for noncommercial distribution and only if you received the program in object code or executable form with such an offer, in accord with Subsection b above.)

The source code for a work means the preferred form of the work for making modifications to it. For an executable work, complete source code means all the source code for all modules it contains, plus any associated interface definition files, plus the scripts used to control compilation and installation of the executable. However, as a special exception, the source code distributed need not include anything that is normally distributed (in either source or binary form) with the major components (compiler, kernel, and so on) of the operating system on which the executable runs, unless that component itself accompanies the executable.

If distribution of executable or object code is made by offering access to copy from a designated place, then offering equivalent access to copy the source code from the same place counts as distribution of the source code, even though third parties are not compelled to copy the source along with the object code.

4. You may not copy, modify, sublicense, or distribute the Program except as expressly provided under this License. Any attempt otherwise to copy, modify, sublicense or distribute the Program is void, and will automatically terminate your rights under this License. However, parties who have received copies, or rights, from you under this License will not have their licenses terminated so long as such parties remain in full compliance.

5. You are not required to accept this License, since you have not signed it. However, nothing else grants you permission to modify or distribute the Program or its derivative works. These actions are prohibited by law if you do not accept this License.

Therefore, by modifying or distributing the Program (or any work based on the Program), you indicate your acceptance of this License to do so, and all its terms and conditions for copying, distributing or modifying the Program or works based on it.

6. Each time you redistribute the Program (or any work based on the Program), the recipient automatically receives a license from the original licensor to copy, distribute or modify the Program subject to these terms and conditions. You may not impose any further restrictions on the recipients' exercise of the rights granted herein. You are not responsible for enforcing compliance by third parties to this License.

7. If, as a consequence of a court judgment or allegation of patent infringement or for any other reason (not limited to patent issues), conditions are imposed on you (whether by court order, agreement or otherwise) that contradict the conditions of this License, they do not excuse you from the conditions of this License. If you cannot distribute so as to satisfy simultaneously your obligations under this License and any other pertinent obligations, then as a consequence you may not distribute the Program at all. For example, if a patent license would not permit royalty-free redistribution of the Program by all those who receive copies directly or indirectly through you, then the only way you could satisfy both it and this License would be to refrain entirely from distribution of the Program.

If any portion of this section is held invalid or unenforceable under any particular circumstance, the balance of the section is intended to apply and the section as a whole is intended to apply in other circumstances.

It is not the purpose of this section to induce you to infringe any patents or other property right claims or to contest validity of any such claims; this section has the sole purpose of protecting the integrity of the free software distribution system, which is implemented by public license practices. Many people have made generous contributions to the wide range of software distributed through that system in reliance on consistent application of that system; it is up to the author/donor to decide if he or she is willing to distribute software through any other system and a licensee cannot impose that choice.

This section is intended to make thoroughly clear what is believed to be a consequence of the rest of this License.

8. If the distribution and/or use of the Program is restricted in certain countries either by patents or by copyrighted interfaces, the original copyright holder who places the Program under this License may add an explicit geographical distribution limitation excluding those countries, so that distribution is permitted only in or among countries not thus excluded. In such case, this License incorporates the limitation as if written in the body of this License.

9. The Free Software Foundation may publish revised and/or new versions of the General Public License from time to time. Such new versions will be similar in spirit to the present version, but may differ in detail to address new problems or concerns.

Each version is given a distinguishing version number. If the Program specifies a version number of this License which applies to it and "any later version", you have the option of following the terms and conditions either of that version or of any later version published by the Free Software Foundation. If the Program does not specify a version number of this License, you may choose any version ever published by the Free Software Foundation.

10. If you wish to incorporate parts of the Program into other free programs whose distribution conditions are different, write to the author to ask for permission. For software which is copyrighted by the Free Software Foundation, write to the Free Software Foundation; we sometimes make exceptions for this. Our decision will be guided by the two goals of preserving the free status of all derivatives of our free software and of promoting the sharing and reuse of software generally.

#### **NO WARRANTY**

11. BECAUSE THE PROGRAM IS LICENSED FREE OF CHARGE, THERE IS NO WARRANTY FOR THE PROGRAM, TO THE EXTENT PERMITTED BY APPLICABLE LAW. EXCEPT WHEN OTHERWISE STATED IN WRITING THE COPYRIGHT HOLDERS AND/OR OTHER PARTIES PROVIDE THE PROGRAM "AS IS" WITHOUT WARRANTY OF ANY KIND, EITHER EXPRESSED OR IMPLIED, INCLUDING, BUT NOT LIMITED TO, THE IMPLIED WARRANTIES OF MERCHANTABILITY AND FITNESS FOR A PARTICULAR PURPOSE. THE ENTIRE RISK AS TO THE QUALITY AND PERFORMANCE OF THE PROGRAM IS WITH YOU. SHOULD THE PROGRAM PROVE DEFECTIVE, YOU ASSUME THE COST OF ALL NECESSARY SERVICING, REPAIR OR CORRECTION.

12. IN NO EVENT UNLESS REQUIRED BY APPLICABLE LAW OR AGREED TO IN WRITING WILL ANY COPYRIGHT HOLDER, OR ANY OTHER PARTY WHO MAY MODIFY AND/OR REDISTRIBUTE THE PROGRAM AS PERMITTED ABOVE, BE LIABLE TO YOU FOR DAMAGES, INCLUDING ANY GENERAL, SPECIAL, INCIDENTAL OR CONSEQUENTIAL DAMAGES ARISING OUT OF THE USE OR INABILITY TO USE THE PROGRAM (INCLUDING BUT NOT LIMITED TO LOSS OF DATA OR DATA BEING RENDERED INACCURATE OR LOSSES SUSTAINED BY YOU OR THIRD PARTIES OR A FAILURE OF THE PROGRAM TO OPERATE WITH ANY OTHER PROGRAMS), EVEN IF SUCH HOLDER OR OTHER PARTY HAS BEEN ADVISED OF THE POSSIBILITY OF SUCH DAMAGES.