

SAS-DVRSET35/45
SAS-DVR1004/1008/1016
SAS-CAM11x0/12x0

MANUAL



Contents

SAFETY INSTRUCTION	5
CHAPTER 1: FEATURES AND FUNCTIONS	6
CHAPTER 2: OVERVIEW	7
2.1 4CH DVR Front Panel	7
2.2 4CH DVR Rear Panel	8
2.3 4CH Remote Controller	9
2.4 Mouse Operation	10
CHAPTER 3: DVR CONNECTION	11
3.1 HDD Installation	11
3.2 Camera and Monitor Connection	11
3.3 Power Supply connection.....	11
CHAPTER 4: DVR BOOT UP	11
4.1 System Initialization	11
4.2 Live Interface	12
CHAPTER 5: DVR MENU	12
5.1 Main Menu Guide.....	13
5.2 Main Menu.....	14
5.2.1 <i>Display</i>	14
5.2.1.1 Live mode.....	14
5.2.1.2 Output mode	15
5.2.1.3 Privacy Zone.....	16
5.2.2 <i>Record set</i>	17
5.2.2.1 Record parameters.....	17
5.2.2.2 Schedule	17
5.2.2.3 Main Stream	18
5.2.3 <i>Search</i>	18
5.2.3.1 Record Search.....	18
5.2.3.2 Channel Select.....	19
5.2.3.3 Time Axis setup, file clip and zoom in/out	20
5.2.3.4 Event Search	21
5.2.3.5 File Backup.....	21
5.2.3.5.1 back-up file based on event	22
5.2.3.5.2 back-up file based on time.....	22
5.2.3.5.3 Play backup file.....	22
5.2.3.6 Log Search	24
5.2.4 <i>Network</i>	24
5.2.4.1 Network set	24
5.2.4.2 Mobile Set	26
5.2.4.3 Router's Port Forwarding	26
5.2.4.4 Sub stream	27

5.2.4.5 Email set.....	27
5.2.4.6 DDNS Set	28
5.2.5 Alarm.....	28
5.2.5.1 Motion.....	28
5.2.5.2 Alarm Set	29
5.2.6 Device.....	30
5.2.6.1 HDD Set.....	30
5.2.6.2 PTZ Set.....	31
5.2.6.3 Serial Set	31
5.2.7 System.....	32
5.2.7.1 General.....	32
5.2.7.2 Users.....	32
5.2.7.3 Information.....	33
5.2.8 Advanced	33
5.2.8.1 Maintain.....	33
5.2.8.2 Event	34
5.3 Menu Lock	34
5.4 Split mode	35
5.5 PTZ Control.....	35
5.6 PIP Mode	36
5.7 Record Search.....	36
5.8 Mute.....	36
5.9 Manual Record	36
5.10 Stop Record	36
5.11 Start Sequence	36
5.12 Start Cruise.....	36
CHAPTER 6: WEB APPLICATION MANAGER.....	37
6.1 ActiveX control download and installation.....	37
6.2 Web Application Manager Log-in.....	38
6.3 Live interface	39
6.3.1 Menu Bar	39
6.3.1.1 Live Display.....	39
6.3.1.2 PTZ Control.....	40
6.3.1.3 Video control.....	40
6.3.2 Playback	40
6.3.2.1 Record search	41
6.3.2.2 Playback control	41
6.3.3 Configuration.....	43
6.3.3.1 Display Configuration.....	43
6.3.3.2 Record	44
6.3.3.3 Network Parameters.....	44
6.3.3.4 Alarm Set	46
6.3.3.5 Device.....	47

6.3.3.6 System.....	47
6.3.3.7 Advanced	48
6.3.4 Local setting	50
6.3.5 Logout.....	50
CHAPTER 7: APPENDIX.....	51
7.1 Operation Function Table.....	51
7.2 Record Alarm setting	53
7.3 Mail box server List.....	53
7.4 Troubleshooting.....	54
7.5 Usage Maintenance	54
7.6 System Connection Diagram.....	55
CHAPTER 8: CAMERAS SAS-CAM1100/1110, 1200/1210	56
CHAPTER 9: MOBILE DEVICE SUPPORT	57
CHAPTER 10: GENERAL INFORMATION.....	58

Safety Instruction

- 1. Read Instruction**

All the safety and operating instruction should be read before the equipment is operated.
- 2. Power sources**

This equipment should be operated only from the type of power source indicated on the marking label. If you are not sure of the type of power, please consult your equipment dealer.
- 3. Objects and Liquid**

Never push objects of any kind through openings of this equipment and/or spill liquid of any kind on the equipment as they may touch dangerous voltage points or short out parts that could result in a fire or electric shock.
- 4. Water and/or Moisture**

Do not use this equipment near water or in contact with water.
- 5. Heat sources**

Do not install near any heat sources such as radiators, heat registers, stoves or other apparatus (including amplifier) that produce heat.
- 6. Dusty field**

Never use this equipment near dusty or intense magnetic field.
- 7. Cleaning**

Unplug this equipment from the wall outlet before cleaning it. Do not use liquid aerosol cleaners. Use a damp soft cloth for cleaning.
- 8. Lightning**

Unplug this equipment during lightning storm or when unused for long periods of time.
- 9. Accessories**

Do not place this equipment on an unstable cart, stand or table. When a cart is used, use caution when moving the cart/apparatus combination to avoid injury from tip-over.
- 10. Moving**

Disconnect the power before moving the equipment. And the equipment should be moved with care.
- 11. Attachment**

Never add any attachments and/or equipment without the approval of the manufacturer as such additions may result in the risk of fire, electric shock and other personal injury.
- 12. Correct Batteries**

Risk of explosion occurs if battery is replaced by an incorrect type. Therefore you must use the same type of battery as the one being used in the product.
- 13. Ventilation.**

Do not block any ventilation openings, installation of the equipment in the rack should be such that the amount of airflow required for safe operation of the equipment is not compromised.
- 14. Overloading**

Do not overload wall outlets and extension cords to avoid the risk of fire or electric shock.
- 15. Reliable Earthlings (Grounding)**

Reliable grounding of rack mounted equipment should be maintained. Particular attention should be given to supply connections other than direct connections to the branch circuit.

Chapter 1: Features and Functions

Function	Brief and Description
Real time monitoring	Double video output; with monitor, VGA virtual output port or HDMI Output; Support net-viewer and MP live surveillance and also support zoom in/out, auto sequence and PIP display.
Record	H.264 video compression format; record quality/resolution/frame rate adjustable, multiple record modes (Always, Scheduled, Manual, Alarm, Motion detection and remote record)
Record storage	Support SATA large capacity HDD and save real-time record image to HDD.
Playback	Support DVR single CH and multiple CH Search/Playback of recorded files.
Backup	Support DVR backup via USB flash drive, removable drive, Recorder and network.
Alarm Setting	Supports HDD & video input alarm management and external alarm signal inputs.
Network operation	Supports remote surveillance by authority users to increase system security.
Mouse Operation	Supports Mouse operation for faster menu navigation.
PTZ Control	Supports PTZ camera operations through RS-485.

Features:

- H. 264 video compression format; supports 960H resolution;
- G.711 audio compression format;
- Windows Graphical interface; embedded real-time Linux2.6 operation system;
- Friendly Menu reminder;
- Multiple operation modes (Preview, record, playback, backup, network surveillance and mobile phone monitoring);
- Supports Double Streaming network transmission;
- Supports remote live surveillance via smart mobile phone;
- Supports Zoom in/out and sequence function;
- The video package time is adjustable;
- Multiple alarm record modes;
- Rear USB2.0 ports for back-up, recorder, upgrade and mouse operation;
- With IR remote control operation;
- Multiple language OSD;
- Support auto-maintain.

Chapter 2: Overview

2.1 4CH DVR Front Panel



Item	Key title /Indicator	Marks	Function
1	HDD indicator	HDD	When the "Red" indicator flashes it means the hard drive is being read or written to
2	Power indicator	PWR	If the "Green" indicator is on the system is getting power normally
3	Menu	MENU/ESC	Enter into main menu / Exit
4	PTZ	PTZ	Enter into PTZ control, select [Enter] / [Edit] operation
5	UP	▲	Move up
6	RIGHT	▶ / ▶▶	Move right / FWD
7	DOWN	▼	Move down
8	LEFT	◀ / ◀◀	Move left / RWD
9	Manual record	●	Press the button to start manual record.
10	Mute	🔇	Open or close audio input
11	USB Port		Connect to USB2.0 port
12	Channel	CH+	channel up
13	Play / Pause	▶	Play or Pause
14	Display quarter	ALL	display quarter
15	Channel	CH-	channel down
16	Search	🔍	Search recording

2.2 4CH DVR Rear Panel



Item	Physical port	Connection method
1	Video input	Connect video input device (BNC interface)
2	Video output	Connect monitor output(BNC interface)
3	Audio Input	4CH audio input (RCA interface)
4	Audio Output	Audio output (RCA interface)
5	USB Port	Connect USB device (Flash Drive, Hard Drive and Recorder etc)
6	HDMI Port	Connect to HDMI device
7	VGA Port	Connect to VGA monitor, such as PC monitor (Optional)
8	RS-485/Sensor/Alarm	RS485/Sensor/Alarm interface (see pin outs below)
9	Power Port	Connect power supply - DC 12 V 3 A
10	Ethernet: Port	Connect LAN, Ethernet (RJ45 interface)
11	Power Switch	Turn Power on and off

RS485/Sensor/Alarm port functions:

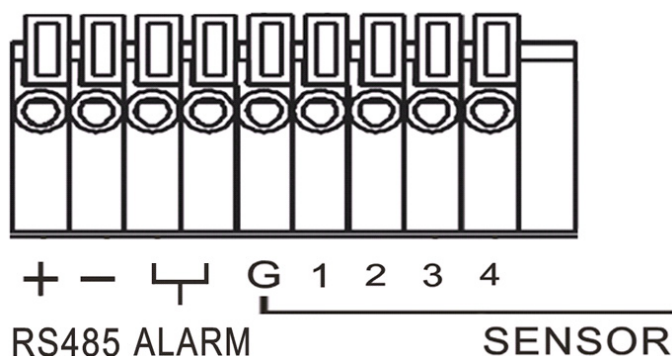

Alarm input: Connect [-] port of your sensor to G (GND) pin, and [+] port to channel input according to the alarm device you purchased.

Alarm output: Connect to the two ports marked with "out"

PTZ Port: Connect your camera to RS-485A and RS485B accordingly.
(other models may vary slightly)

2.3 4CH Remote Controller

Item	Key title	Key function
1	Mute	Mute on/off
2	ALL	Multiple display mode
3	1-8 9, 0	Channel select 1-8 Clicking numeric "0" allows you switch to output device
4	Menu	Enter into Main menu/Exit
5	Submenu	Enter into Submenu (toolbar)
6	▲▼ ◀▶ SEL	Up arrow key, Volume adjust Down arrow key, Volume adjust Left/Right key, Decrease/increase parameter value of control bar Select key/Edit key, Confirm the selected operation
7	◀◀ ● ▶ ▶▶ ■	Rewind key Record key Enter into record search menu, Play key Pause/Sequence key Forward key Stop manual record; stop playing

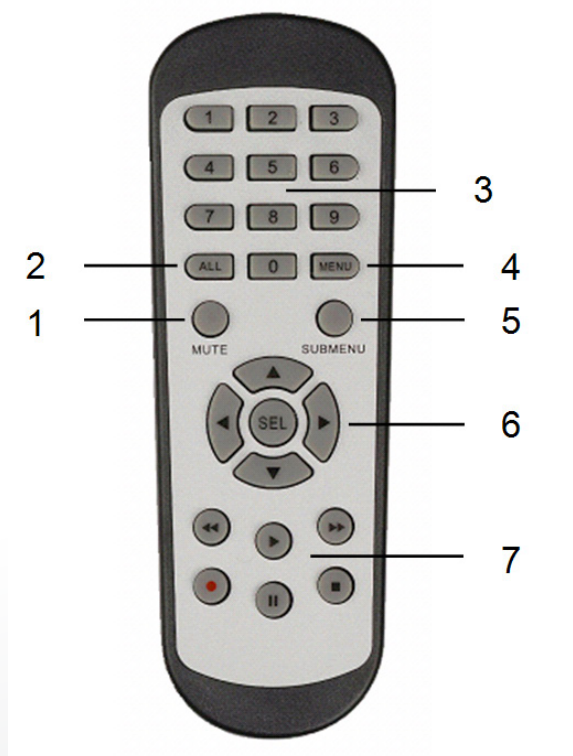

2.4 Mouse Operation

Except using buttons of front panel or remote controller, you also can use mouse to perform system operation.

TYPE	Function
Click left key of Mouse	In menu lock mode, enter into pop-up menu and click any sub menu to pop up Log-in window; on menu unlock mode, enter into pop-up menu, and then click left key to enter into any sub menu directly.
	After entering into main menu, clicking left key could enter into any sub menu; On [Detailed file] menu mode, clicking left key could playback one recording file.
	Change the status of check box and motion detection area.
	Clicking combo box to access pull-down menu; Click left key to stop dwell time display when dwell time display is activated.
	By clicking left key you can adjust Color control bar and volume control bar.
	Clicking combo box to access pull-down menu By clicking left key you can select values in edit boxes or pull-down menu and supports Chinese word input, special symbol, numeric and character input, use instead of [Enter- 
Click right key of Mouse	In live display mode, clicking right key will display pop-up menu (shown as Picture 5-1).
	In Main menu or sub menu mode, clicking right key will exit current menu.
Double-click Left key of Mouse	In live display or playback mode, double-clicking left key will maximize the screen.
Moving Mouse	Select menu item
Sliding Mouse	On motion mode, sliding mouse will select motion area; On [Color set] menu mode, sliding mouse will adjust color control bar and volume control bar.

Chapter 3: DVR CONNECTION

3.1 HDD Installation

Caution: Please do not Install or take out hard drive when DVR is running!

HDD Installation:

- (1) Cut power firstly, and then remove screws and open DVR upper cover carefully;
- (2) Insert Power Cord and data cable into Pin of hard drive securely;
- (3) Remove the screws on the HDD bracket; fix the HDD to the bracket and then fix the bracket with HDD to DVR body;
- (4) Put the upper cover back carefully, re-attach screws.

Note: If user requires higher performance HDD, strongly recommend you use special hard driver for security and protection.

3.2 Camera and Monitor Connection

Connect camera cable to video input of DVR, and from video output of DVR to Monitor via BNC connector (Refer to section 2.2-Rear Panel); or

If the camera is a PTZ speed dome, you could connect RS485 A & B to the according port of DVR respectively (refer to system figuration on Chapter 8).

3.3 Power Supply connection

After power on please make sure the video I/O connection well, audio device with BNC cable.

Chapter 4: DVR Boot up

4.1 System Initialization

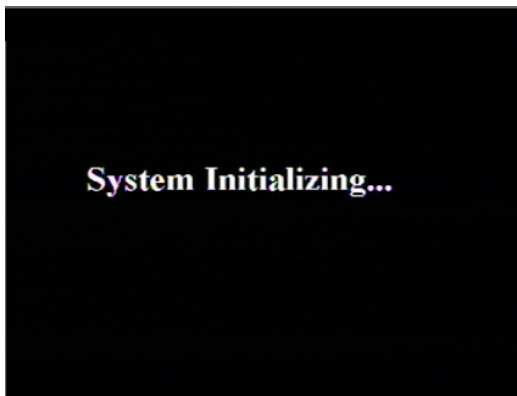

Picture 4-1

After connecting the Power cable of DVR to wall outlet and pressing the Power button on the front panel, you will enter into the system initializing screen shown as Picture 4-1.

4.2 Live Interface



Picture 4-2

After finishing initialization the system will enter into <Live> screen. Picture 4-2 is the 16-split display defaulted by system, which is showing no video input status. Once there are video inputs, the screen will display live images from the cameras. In Live mode, if you use the mouse to double-click the live image of any channel, the image will be maximized to full screen, by double-clicking again, image will be come back to 16-split display mode; clicking the right button of the mouse will enter into Pop-up Menu; clicking the left button of the mouse allows you select menu items; and clicking any area outside the menu allows you exit the Pop-up menu.

Note: When internal HDD is not connected or an error occurs, the character “H” will appear on the first channel of the live screen and accompany buzzer alarm. If you want to close the buzzer alarm, please enter into [Main menu→Alarm] to set HDD loss, HDD space not enough and alarm output to “off”

Chapter 5: DVR Menu

Pop-up Menu

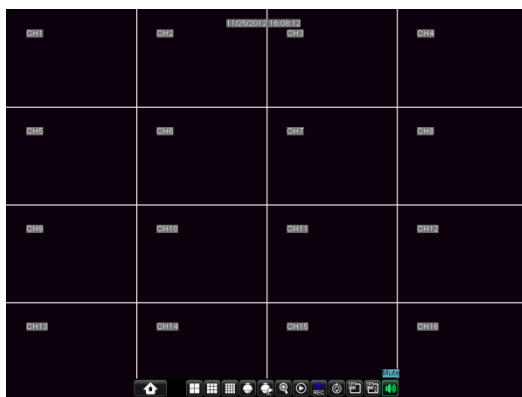

Picture 5-1

After finishing system initialization, click right key of mouse on main interface mode to enter into Pop-up Menu. Now you could perform parameter setting and operate on Main Menu, Multi-Pics, PTZ, Auto Cruise, Zoom in/out, Rec. Search, Manual record, Sequence, PIP, and Vo Switch etc. Clicking [0] key on the remote controller or holding press [Esc] key on the front panel could switch system to other output device.

5.1 Main Menu Guide

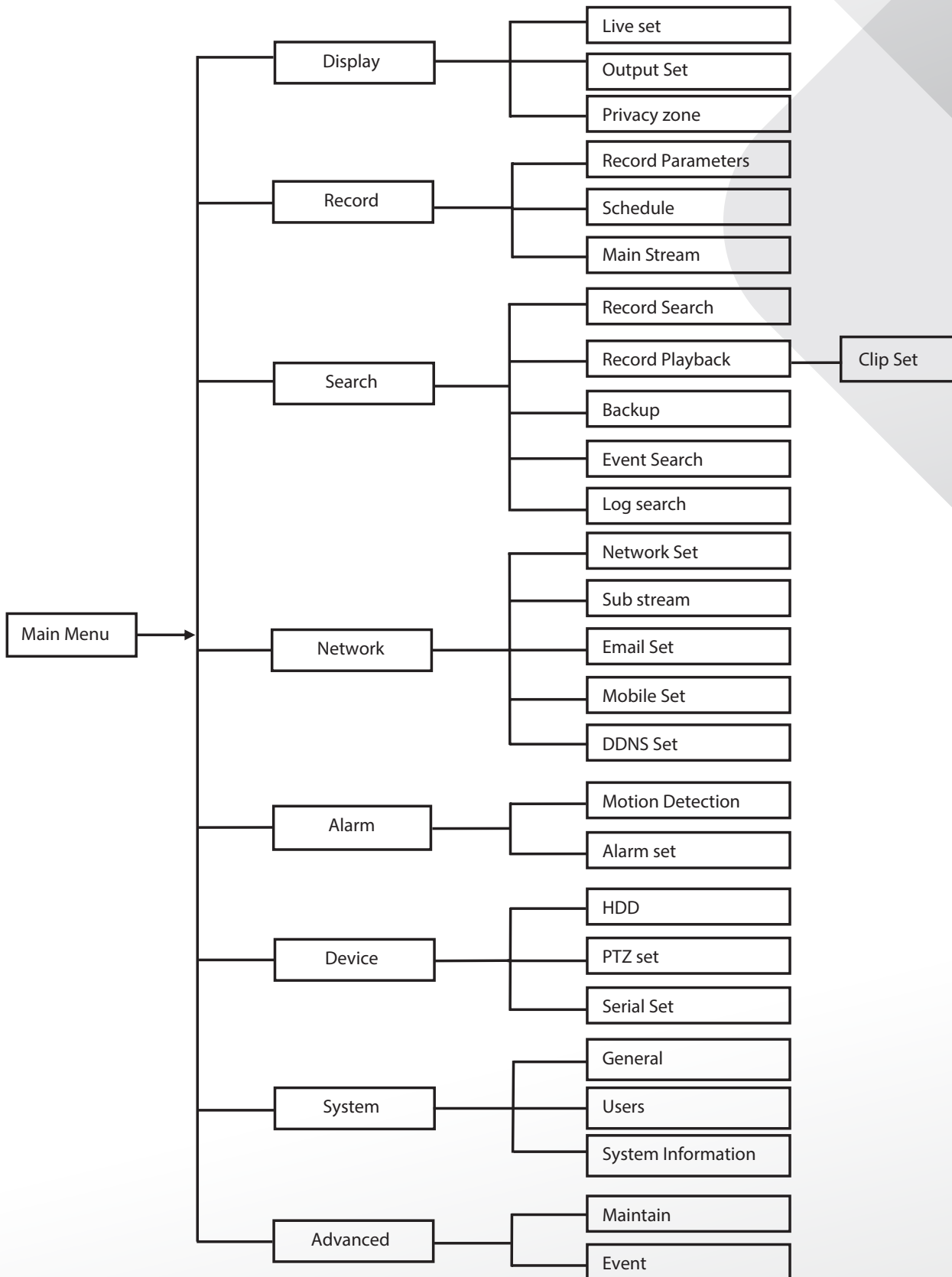

5.2 Main Menu



Picture 5-2

On <Live> mode, click [Menu] button on the front panel or Remote controller to enter into Main menu interface shown as Picture 5-2. And also you can click [] icon to enter the main menu screen. In Main Menu mode, you can control device management settings, such as Display, Record, Network, Search, Device, System and Advanced setting etc.

5.2.1 Display

5.2.1.1 Live mode

Go to <Main menu>→<Display>→<Live> option and enter into the <Display> setting interface shown as Picture 5-3.



Picture 5-3

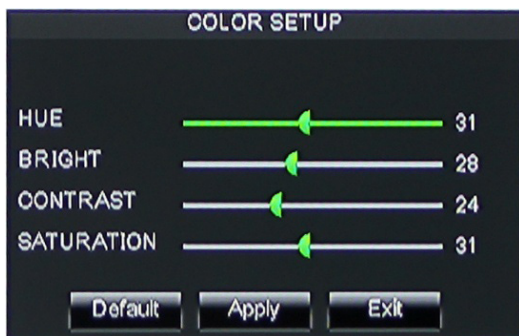

Picture 5-4

- **Channel:** allow you setup the channel you desired.
- **Name:** allow you setup the channel name, and system support up to eight characters or four Chinese characters.
- **Position:** allow you setup the display position of each channel.
- **Color:** Click [Setup] option to enter into the [Color setup] interface shown as Picture 5-4.
- **Covert:** allow you enable [Live] surveillance screen
- **Show time:** allow you enable system time appear in the <Live> screen.
- **Record time:** When set to "Enable", you are allowed to record system time into the record history.
- **Copy:** allow you copy all data of one channel to any other one

Left picture 5-4 is the Color setup Menu where you can adjust image brightness, saturation, contrast and hue parameters of each channel.

Explanation:

1. The modifications will be available after clicking [APPLY] button on the bottom of the sub-menu windows and being prompted to save and then clicking [ok] button.
2. If you want to cancel the modification, click [Exit] button to exit the menu.
3. When clicking [DEFAULT] button, all system default values will be reset to default value.
4. System default value indicates the value pre-set at the factory.

5.2.1.2 Output mode

Go to [Main menu→Display→Output] to enter into the output set interface shown as Picture 5-5.

Go to [Main menu→Display→Output] to enter into the output set interface shown as Picture 5-5.

Click [Live] to pop up the interface shown as Picture 5-6. Now you could perform channel sequence setting.



Picture 5-5

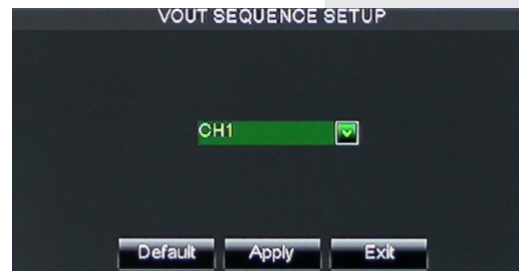

Picture 5-6

Click [Spot output] option and set relative parameters shown as Picture 5-7.

Click [Spot sequence] to enter into the interface shown as Picture 5-8.



Picture 5-7

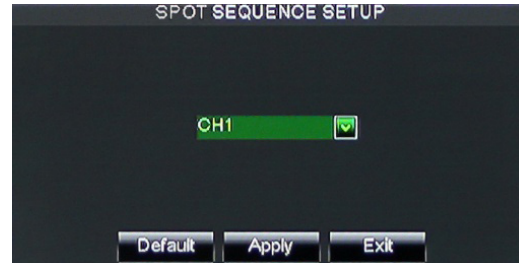

Picture 5-8



Picture 5-9

- **Video output:** Support CVBS output Live and Spot mode simultaneously, and Live is main output, and Spot is auxiliary output.
- **CH Sequence:** the option is defaulted to "Off" and sequence time is 5 second. User can activate the option as per request.
- **Rotate time:** allow you set sequence time, and minimum time can be set to 3 seconds.
- **VGA/HDMI Resolution:** allow you select VGA or HDMI output, including 800x600, 1024x768, 1280x1024, 1440x900 and 1920 x 1080.

- **Display Mode:** Live output: display window will include Single, Quad, 9-split and 16-split mode.
- **Spot output:** display window will include Single, Quad and 9-split mode.

- **Transparency:** allow you adjust menu's transparency, and its range is 1~128.
- **Margin:** allow you adjust the whole screen's margin. Details operations please refer to the Picture 5-10. **Volume:** allow you adjust the DVR volume shown as Picture 5-11.



Picture 5-10



Picture 5-11

5.2.1.3 Privacy Zone

The function Allow you setup privacy zone parameters according to Picture 5-12. Each channel could set up to four privacy zones, and please follow below steps to set:

1. Select the area no (Area 1 ~ Area 4);
2. Click [Setup] to adjust position of mask area;
3. After finishing position adjust, click right key of mouse to return back [Privacy zone] interface;
4. Click [Apply] to save the above setting.

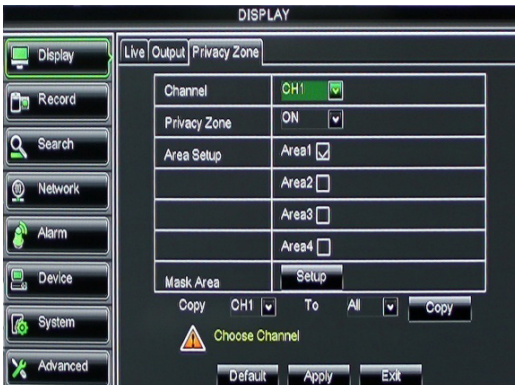

Picture 5-12



Picture 5-13

5.2.2 Record set

5.2.2.1 Record parameters

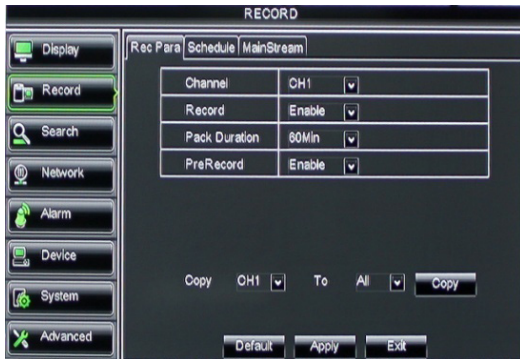

Picture 5-14

Click [Main menu→Record→Record Para] to enter into the interface shown as Picture 5-14.

- **Channel:** allow you setup the channel you desired.
- **Record:** allows you set up record status (Enable/Disable) of each channel
- **Pack Duration:** indicates maximum continuous record time (15, 30, 45 and 60 min).
- **Pre-record:** Motion detection and I/O triggered record support Pre-record function.

5.2.2.2 Schedule



Picture 5-15

Click [Main Menu→Record→Schedule] to enter into the interface shown as Picture 5-15.

[Channel] option allows you select one channel you desired.

To setup weekly schedules, tick-select the box of the record status you want (Alarm, General, or No Record) and then click on each box in the schedule time line that you want this method to apply to. You can use the [Copy – To] pull-down menus and Copy button to copy settings from one day to another day or all days.

After you complete the schedule you activate it by clicking the [Apply] button.

You can also click on the Default button to use the system defaults.

Explanation: Under the <record> menu and <search> menu, original color stands for no record, "Red" stands for alarm record, "yellow" stands for Motion record and "Green" stands for normal record.

5.2.2.3 Main Stream

Go to [Main menu→Record→Main Stream] to enter into the interface shown as Picture 5-16.



Picture 5-16

As for the DVR of SDI series, the set is below:

Go to [Main menu→Record→Main Stream] to enter into the interface shown as Picture 5-16-2.



Picture 5-16-2

- **Resolution:** support 960H and D1.
960H: includes WD1, WHD1 and WCIF;
D1: include D1, HD1 and CIF
- **Frame rate:** PAL: 1-25 f/s; NTSC: 1-30 f/s.
- **Bit rate:** user could select the relative value by pull-down menu.
- **Audio:** When tick-selecting the option, system will record video stream with audio simultaneously.

- **Resolution:** support 1080P
- **Frame rate:** PAL:1--25f/s; NTSC: 1--30f/s
- **Bit rate:** it is used for saving in DVR, user can select best/better/good three type.
- **Audio:** after tick-selecting the option, audio would be recorded simultaneously by system and come out with video in playback. On the contrary, audio would be non-record and missing in playback when the option is blank.

5.2.3 Search

5.2.3.1 Record Search

Click [Main Menu→Search→Record Search] to enter into the interface shown as Picture 5-17.

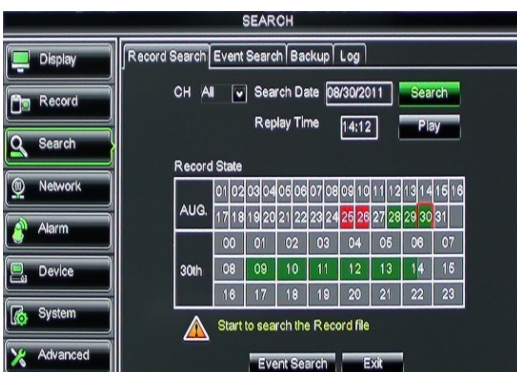

Picture 5-17

- **Channel:** allows you select the channel(s) you desire to search.
- **Date Search:** In the Video Search screen, user can search for all the records in a specific date. To execute a video search, highlight and select the date numeric field, and then click a detailed time quantum of the specific date, system will start the playback from the first record of the time quantum.

- **Time Search:** In the <Search screen>, user can search for a specific date and time for a recording and view it in Playback mode. This is useful for hunting a specific recording of an incident if you know the date and time it occurred.
- **File List:** click [File List] button to enter into the [Event Search] screen shown as Picture 5-19, the video records for the time quantum will appear in the screen.
- **Playback Mode:** You can use the Playback Control bar to operate the Fast Forward (X2, X4 and X8), Slow play (1/2, 1/4 and 1/8 speed), Play, Pause/Frame, Rewind (X2, X4 and X8). When ending playback, DVR will return back to previous menu shown as Picture 5-20.
- **Play control Bar:** the play control bar will display current playing processing shown as Picture 5-20. When user click any time at the control bar and this point have not any record file, system will auto return back to previous menu.

5.2.3.2 Channel Select

Click [Main Menu→Search→Record search] to enter into the interface shown as Picture 5-18

Then tick-select the channel you want to playback; and click [Play] button to enter into the playback mode shown as Picture 5-19

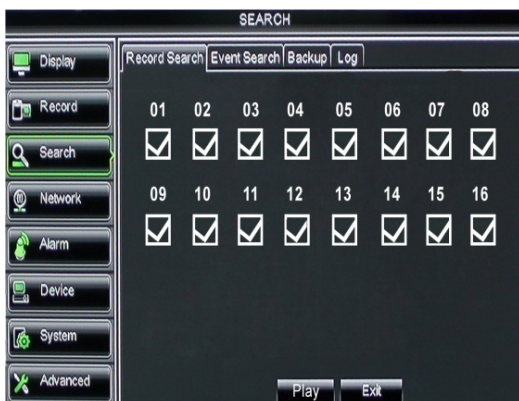

Picture 5-18



Picture 5-19

5.2.3.3 Time Axis setup, file clip and zoom in/out

- 1) The DVR supports the processing control bar function when playing back record files shown as Picture 5-19A (Up to 4CH is available).
- 2) Click [⚙️] icon beside [🔍] the processing bar to pop up the interface shown as Picture 5-19A-1.



Picture 5-19A



Picture 5-19A-1

- **Time Axis:** defaulted to 24hours, and allow user select 2hours, 1hour, 30minutes or user-defined.

Detailed operation is as follows:

- (1) Fixed time axis: If you select [2H] option, that means the processing control bar cover two-hours video content.
- (2) User-defined: select [👤] option and move the cursor to processing bar to select start time and/or end time (that is to say, click any points of the processing bar as start time and/or end time), Now, the whole time axis equals the time quantum you just selected (shown as Picture 5-19B-1).



Picture 5-19A-2



Picture 5-19B-1

- Record Clip and backup function and Zoom in/out function

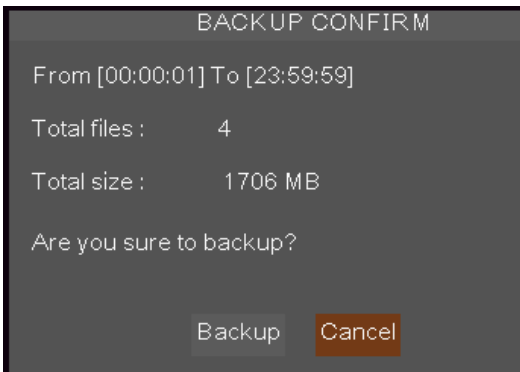

Picture 5-19B-2



Picture 5-19C

- Clip and backup: When one channel is playing-back, the [📄] icon will appear in the [Play control] bar shown as Picture 5-19B-1. Click the icon to start video clip function, click it again to end the function and pop up the dialog shown as Picture 5-19B-2. Now, allow you select if you will save the clipped video file.
- Zoom Function: When one channel is playing-back, the [🔍] icon will appear in the [Play control] bar. Click the icon to zoom in one area of the playback screen shown as Picture 5-19C.

5.2.3.4 Event Search

Click [Main Menu→Search→Event Search] to enter into the interface shown as Picture 5-20. You could highlight and double-click the desired record for playback. And you also can filter the records you want to view based on date, time, and channel and record mode search.

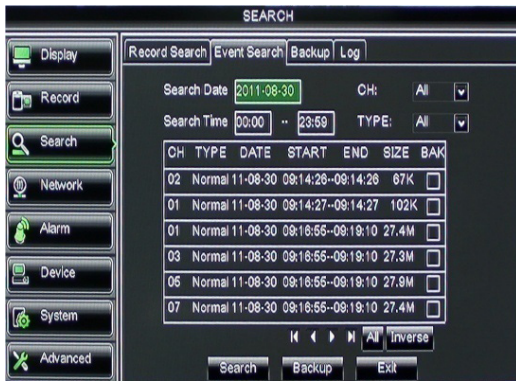

Picture 5-20

- ⏪ **(First Page):** go to the first page on the list. When you view other pages, clicking [First] button brings you back to Page one.
- ⏪ **(Previous page):** go to the previous ones of current page. Clicking [Pre] button will take you back the previous ones of current page (except the first page).
- ⏩ **(Next page):** go to the next ones of current page. Clicking the [Next] button will take you to the next ones of current page (except the last page)
- ⏩ **(Last page):** go to the last page. Clicking the [last] button will make you enter into last page quickly.
- ALL (Select all):** Allows you to select all the events on the current page.
- Inverse (Select Invert):** Allows you to select other events on the current page except those you have currently selected.

5.2.3.5 File Backup

You can back-up the record files based on event or time.

5.2.3.5.1 back-up file based on event

In the [File List] mode, if you wish to backup records, please tick-select the BAK check-boxes which correspond to the records and click [Backup] button to enter into the below windows illustrated in Picture 5-21.

In the [File List] mode, if you wish to backup records, please tick-select the BAK check-boxes which correspond to the records and click [Backup] button to enter into the below windows illustrated in Picture 5-21

Select USB as backup device and click [Apply] button, and then enter into the window shown as Picture 5-22.

Select DVD as backup device and click [Apply] button, and then enter into the window shown as Picture 5-23.

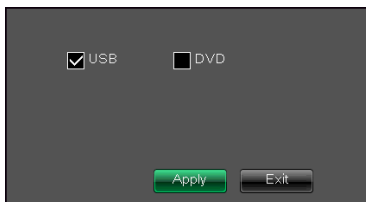

Picture 5-21

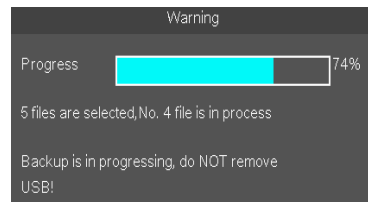

Picture 5-22

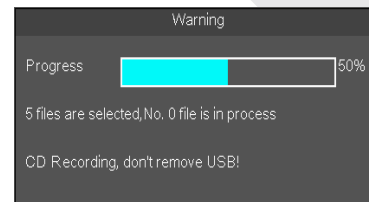

Picture 5-23

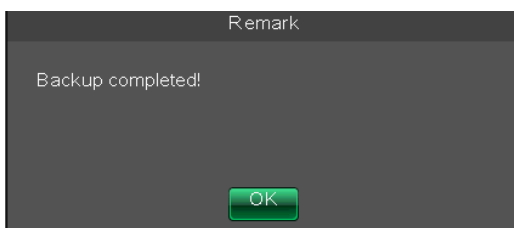

Picture 5-24

After backup finished, please click [OK] button shown as Picture 5-24.

Note:

- File will be saved as *.264 format.
- You could playback the record files via Dvr Client player. When installing Dvrclient, system will auto install the player.
- DVD file will be saved as *.nvr format.

Note: Please make sure the back-up device (U Flash disk, USB port or DVD Recorder) connect well before backup.

5.2.3.5.2 back-up file based on time

Also allow you back-up record files based on time. Please follow below steps to back up these files (Details operations please refer to section 5.3.4.4.1):

1. Input start time and end time on the time edit box;
2. Click [Search] button;
3. Tick-select all the files you desire to backup;
4. Click the [Backup] on the bottom.

5.2.3.5.3 Play backup file



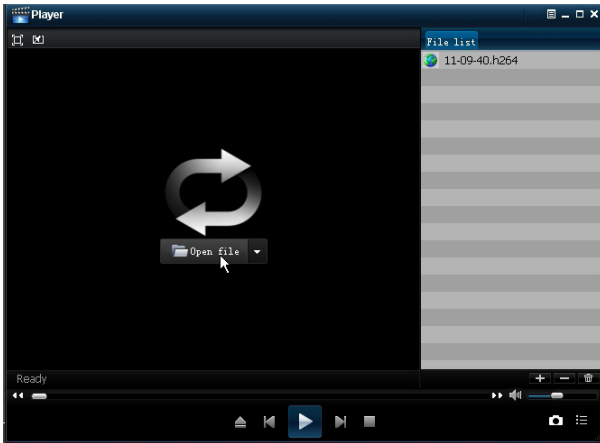



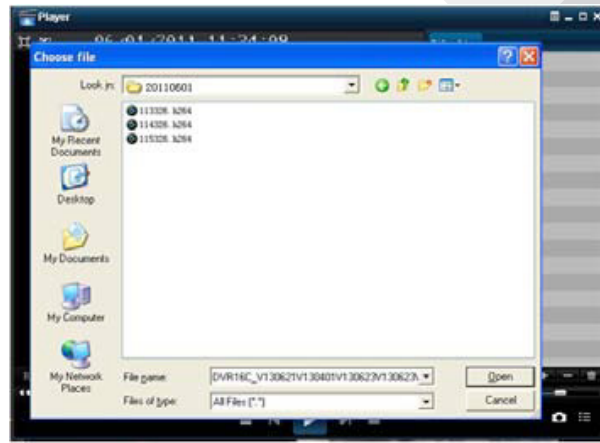







1. Copy one backup file to your PC.
2. Open Playback player and click "+" icon or  button to find/select the backup file, and then click [open] button.
3. Highlight the file you have selected and click [Play] button.



Picture 5-25



Picture 5-26

-  Play button: click the icon to playback the backup record
-  Pause button: click the icon to pause the backup record
-  Stop button: click the icon to stop the backup record
-  Next: Click the icon to play next record
-  Prev.: Click the icon to play previous record
-  FF button: click the icon to fast forward the backup record at x2, x4, x8 and/or x16 speed
-  Open: click the icon to open one record file
-  Click the icon to place the playing record to top
-  Snapshot button: click the icon to capture the live image and save the captured one to directory:\\video client\capture
-  Volume Adjust: click the icon to adjust the volume
-  Add fold or file to player
-  Delete one file in the list
-  Delete all the files in the list
-  Unfold or fold the list files
-  Advance Configuration: click the icon to set One capture path and language shown as Picture 5-27

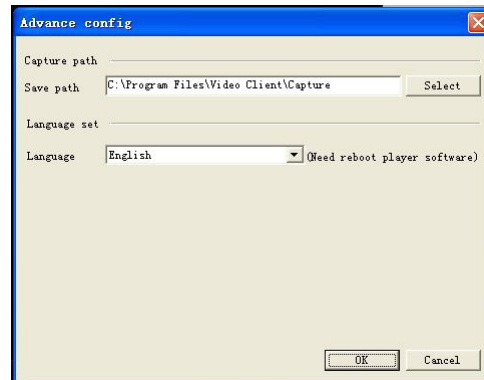

Picture 5-27

5.2.3.6 Log Search

Go to [Main menu→Search→Log] option to enter into the Log search interface shown as Picture 5-28.

Herein allow you preview the log information you have searched. And click [Backup] to export all the log information which is listed. For other button functions please refer to previous section 5.2.3.4-Event Search.

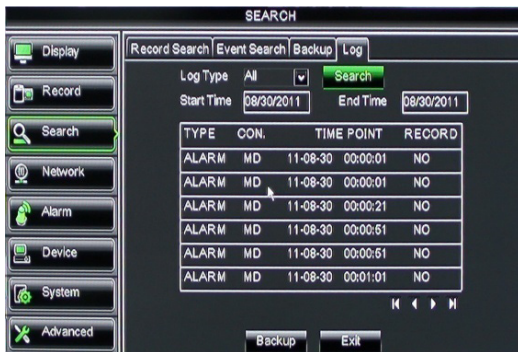

Picture 5-28

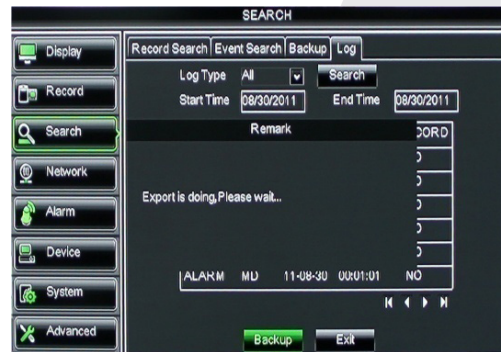

Picture 5-29

5.2.4 Network

5.2.4.1 Network set

Click [Main menu→Network→Network] to enter into the below interface shown as Picture 5-30.

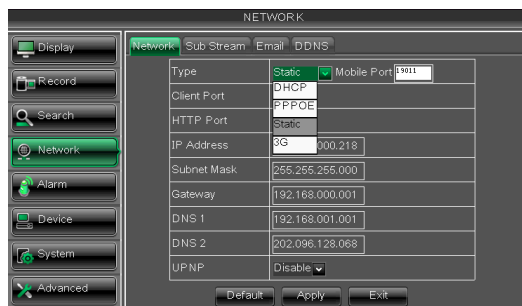

Picture 5-30

After selecting network mode - such as DHCP, PPPOE or static allocation- and setting up web ports, you can visit DVR remotely through a network or internet. **UPnP (Universal Plug and Play) function:** If router supports UPnP function and set <UPnP> to "Enable", system will automatically forward port to router.

DNS: DNS server is generally provided by local ISP. Herein please enter the IP address of your DNS



Picture 5-31

When selecting DHCP from the Type, A router will automatically allocate IP address for your DVR. After restarting each time, the IP address captured by your DVR may be different. So, port forwarding is required when you visit a remote DVR.

1. Select DHCP and click [Apply] button;
2. Exit and restart DVR;
3. Input media port and HTTP port

4. Set IP address captured by DVR and HTTP port to a router

5. Visit a remote DVR
 http:// public net IP: HTTP port (such as: 19010)
 http://intranet IP: HTTP port (such as: 19010 - only use for Intranet)
6. Input the IP address of your domain name server

Friendly Reminder:

1. All the parameters you set are available only when you click [Apply] and after system are restarted.
2. **User needs to change MAC address when there are multiple DVRs at the same local area network. Details please refer to section 5.2.7.3 Information.**

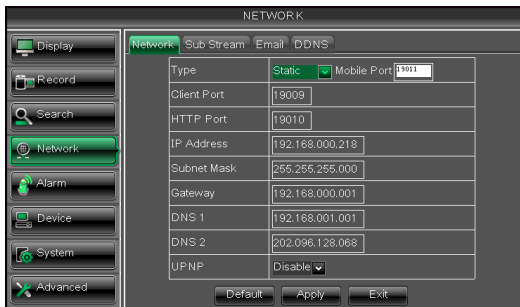

Picture 5-32

When selecting Static from the Type, user can directly input IP address, Subnet Mask, Gateway and DNS shown as below picture 5-32.

1. Set your net type to Static;
2. Set Client port number (such as 19009), and the port need to be forwarded to a router.
3. Input HTTP port number (such as 19010), and the port need to be forwarded to a router;

4. Input a specified IP address to [IP address] column;
5. The Subnet Mask, gateway and DNS server should be consistent with your router's configurations.
6. Input DNS address. Please check router firstly. The setting should be consistent with routers
7. Click [Apply] button

Now you could remotely visit the DVR via IP

http:// public net IP: HTTP port (such as: 19010)

http://intranet IP: HTTP port (such as: 19010 - only use for Intranet)

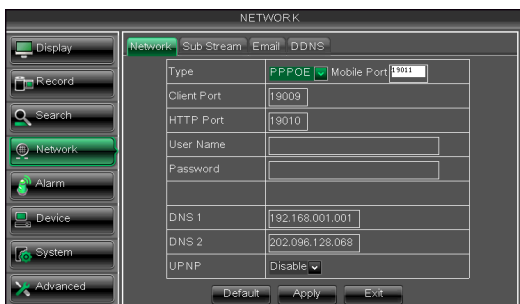

Picture 5-33

When selecting PPPoE from the Type, user can input user name and password provided by ISP and set Media and HTTP port. And now you can visit your remote DVR by using the IP address captured after registering a domain name and HTTP port and connect to your DVR via public network.

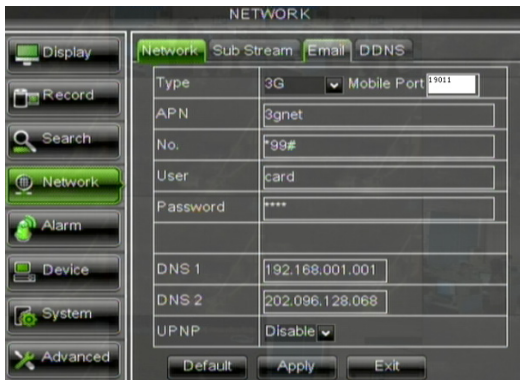

Picture 5-34

When selecting 3G from the Type. Details please follow below steps:

1. Input Mobile Port
(China Telecom:#777;Others: *99#)
2. Click <Apply>. System will automatically capture IP.
3. Enter IP address:web port to visit DVR remotely.

Under the above four net mode, you can visit your remote DVR via DDNS and apply for free DDNS account from the websites: www.3322.org or www.dyndns.org.

5.2.4.2 Mobile Set

The DVR is currently compatible with mobile phones running Andriod, Windows Mobile, Symbian operating systems, Iphone and Black berry on 3G networks.

Please follow below steps:

1. Configure network parameters, details please refer to section 5.2.4.1;
2. Configure mobile port no (such as 19011); and the port need forward to router. Details please refer to section 5.2.4.3;
3. Save the parameters and exit Main Menu;
4. System auto restart;
5. User name and password of mobile is consistent with DVR.

5.2.4.3 Router's Port Forwarding

Port forwarding is required when you want to access the DVR connected to the router from outside of the router's network. If PPPoE is selected, port forwarding is not required.

1. Input router's IP address from IE-based browser to open the Router configuration interface shown as Picture 5-35;
2. Click [Transmittal rule] option to take you to the port forwarding instructions for your router;
3. The DVR IP address for the intranet should be <192.168.1.101>, you should forward Media port (19009) and HTTP port (19010) to this IP address respectively;
4. Now user can visit the DVR remotely.

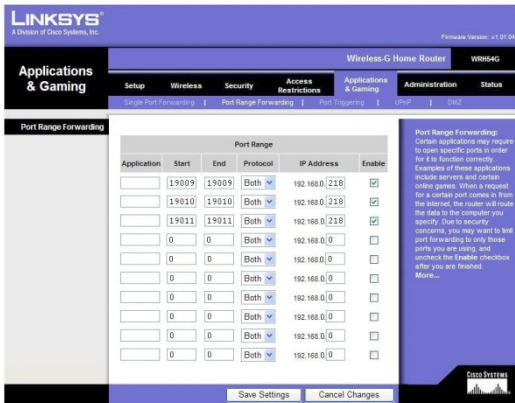

Picture 5-35

Friendly Reminder: The router’s port forwarding interface may be different, however, when entering into virtual server, user will always need forward port (range: 1025~65535) of router to IP address of DVR allocated or automatically captured, and select [All] or [Both] in corresponding protocol column and save the above setting.

Above steps may differ from the router device depending on the manufacturer.

5.2.4.4 Sub stream

Go to [Main menu→Network→Sub Stream] to enter into the interface shown as Picture 5-36

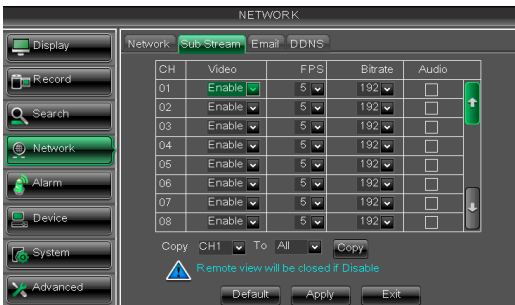

Picture 5-36

- **Video:** allow you open or close the sub stream output. If you select “Enable” system will select sub-stream preview and guarantee image quality once network is unstable.
- **Frame rate:** allow you set net transmittal frame rate. User could select the relative value by pull-down menu.
- **Bit rate:** allow you set net transmittal bit rate. User could select the relative value by pull-down menu.
- **Audio:** When tick-selecting the option, system will record video and audio simultaneously.

5.2.4.5 Email set

Click [Main Menu→Network→Email] option to enter into the email set interface shown as Picture 5-37

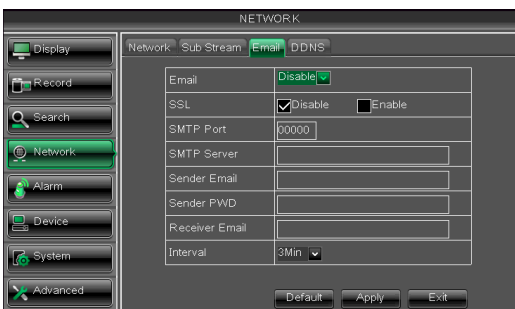

Picture 5-37

SSL: is a security link transport protocol. You can encrypt your communication info (including your email) using SSL to prevent hackers from monitoring your email or communication info and even your password.

Please set SSL to “On” via Gmail.com server, and set to “Off” via other mail server.

- **SMTP Port:** indicate one kind of mail transmittal port opened by Simple Message Transfer Protocol (SMTP). The port number for most mails is 25 except such as Gmail server (Port No.: 465).
- **SMTP server:** indicates server address you used.

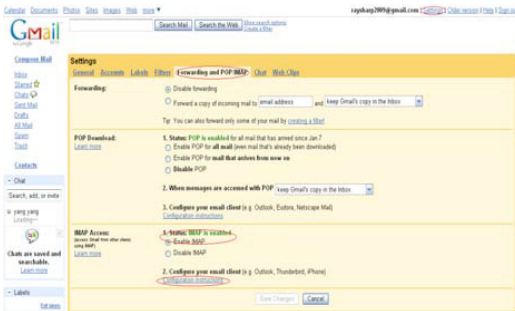

Picture 5-38

- **Sender address:** indicates sender's email address. The email address should be consistent with the server you use. That is to say, when you use email address – aaa@gmail.com, the according server should be smtp.gmail.com.
- **Receiver address:** indicates receiver's email address. The email address is used to receive image transmitted from DVR alarm. Please clear the images you have received as soon as possible to avoid overloading your email account.

5.2.4.6 DDNS Set

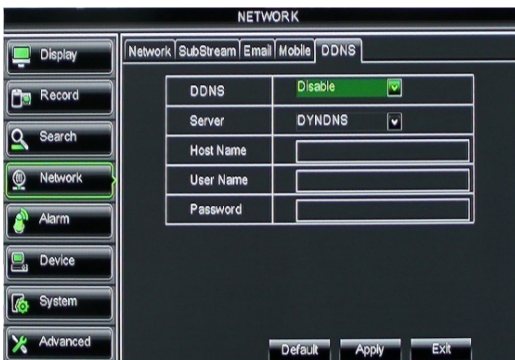

Picture 5-41

- **Server:** select DDNS provider
- **Host name:** input the host domain name you have registered at dynamic domain name system, such as: DVR2009.3322.org;
- **User Name:** Input a user name registered before applying for a domain name;
- **Password:** Input a password you set when registering a user name.

Click [Apply] button and restart the DVR; and then enter the domain name (such as: http://superdvr.3322.org:8080) to visit your remote DVR.

5.2.5 Alarm

5.2.5.1 Motion

Click [Main menu→Alarm→Motion] to enter into the interface shown as Picture 5-42.



Picture 5-42

- **Channel:** allow you enable/disable the motion function for any channel.
- **Area:** Click the [Setup] button to enter into area setup interface shown as Picture 5-41.
- **Sensitivity:** allow you to set sensitivity level of motion detection from higher to low with 8 being the most sensitive.
- **Alarm out:** allow you connect external alarm sensor.

- **Latch time:** you can set how long the buzzer will sound when object move is detected (10s, 30s, 40s, 60s).
- **Show Message:** You can set show message on the screen when motion alarm is detected.

- **Buzzer time:** you can set how long the buzzer will sound when motion is detected (off, 10s, 30s, 40s, 60s).
- **Send Email:** Allows you set the alarm images is issued to a specified email.
- **Full screen Alarm:** The function is defaulted to "On". When the motion is detected, the corresponding channel will be switched to the full screen mode.
- **Record Channel:** the record channel will be activated when the object move is detected.
- **Post Recording:** you can set how long alarm record will last when alarm ends (30s, 1minutes, 2minutes, 5minutes).
- **Copy:** allow you copy current channel parameters to any other channel or all channels.

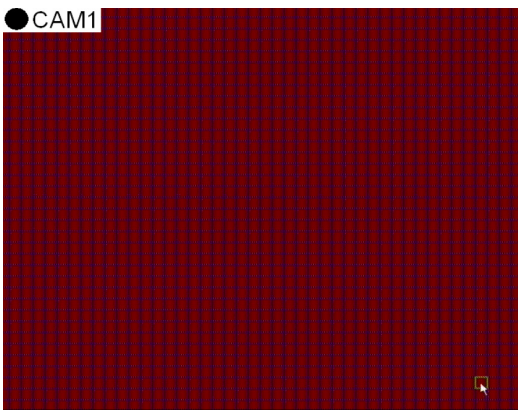

Picture 5-43

The channel will be separated into a 44x36 grids (PAL/NTSC mode). When any object moves into the motion detection area, and the area where the object is located is displayed in red and motion detection will be triggered. In the semi-transparent area the motion detection is not activated.

After configuring the above parameters, click <OK> to save it.

5.2.5.2 Alarm Set

Click [Main Menu→Alarm→Alarm] to enter into the below window shown as Picture 5-44. Now you can perform alarm set based on different status. Details please refer to List 5-1

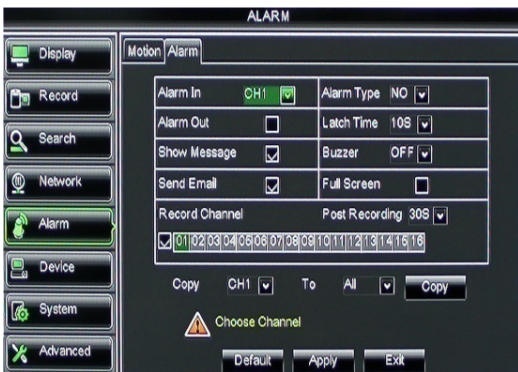

Picture 5-44

- **No:** allow you select one desired channel
- **I/O Status:** allows you select the three options – NO (Normal Open), NC (Normal Close) and OFF. Set to "Normal Open", I/O status Alarm will be activated while sensor is ON; set to "Normal Close", I/O status alarm will be activated while sensor is OFF; set to "OFF", I/O status alarm will not be triggered.
- **Alarm out:** allow you connect external alarm sensor.

- **Latch time:** you can set how long the buzzer will sound when external sensor alarm is detected (10s, 20s, 40s, 60s).
- **Show Message:** You can set show message on the screen when sensor alarm is detected.
- **Buzzer time:** you can set how long the buzzer will sound when sensor alarm is detected (Off, 10s, 20s, 40s, 60s).
- **Send Email:** Allows you set the alarm images is issued to a specified email.
- **Full screen Alarm:** The function is defaulted to "On". When the motion detection or external alarm is triggered, the corresponding channel will be switched to the full screen mode.

- **Record Channel:** allow you select channels you want to record.
- **Post Recording:** you can set how long alarm record will last when alarm ends (30s, 1minute, 2minutes, 5minutes).
- **Copy:** allow you copy all the setting of one channel to other ones.

Alarm Type	Function
Video Loss	Sends alarm when DVR can't receive video signal (such as camera damage, cable broken or damaged or power supply malfunction).
Motion Detection	When an object moves into motion detection area, alarm will be triggered. You can adjust sensitivity level to suit the needs of your actual application environment.
I/O Status	System can convert alarm signal triggered by external sensor into signal identified by system.
HDD loss	When Hard Drive is not detected (HDD damage, power supply malfunction), or HDD auto-overwrite is off, and free space is not enough, an alarm will be triggered.

List 5-1

5.2.6 Device

5.2.6.1 HDD Set

Click [Main menu→Device→HDD] to enter into the interface shown as Picture 5-45.

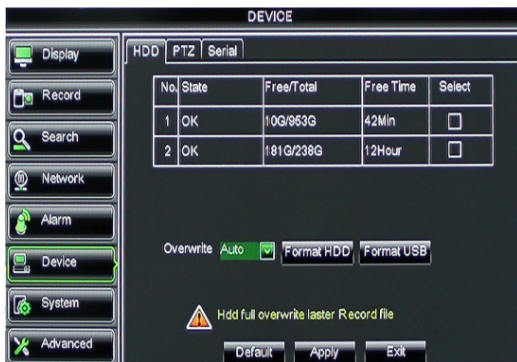

Picture 5-45



Picture 5-46

When DVR is connected to a HDD, the system will automatically detect if HDD is normal or not; If the cable connected to HDD is loosen or HDD is abnormal, HDD status will be shown as "No Disk", or, If HDD need to be formatted, status will be shown as "no format", otherwise, the HDD status will be shown as "Normal"

- **NO:** indicate HDD no pre-seted by system.
- **Status:** It will be available only when HDD have been formatted.
- **Total Space:** Total size of the hard drive currently installed.
- **Free Space:** Total amount of free space available on the hard drive currently installed.
- **Useable Rec. Time:** Free space currently available in hours.

- **Auto-overwrite:** When set to ENABLE the DVR will record over the oldest files on the hard drive. The DVR will always be able to record events as they happen, however, it does mean that you'll need to get important events off the HDD before they're overwritten; and if overwrite is set to DISABLE the DVR will stop record once the DVR is full. Whilst you won't lose old footage, you run the risk of missing new events as they happen. Be sure you want to do this before selecting it.
- **HDD Format:** Formatting the HDD will erase all data (i.e. footage) which is stored on it, and re-create the FAT (file allocation table).
- **USB Format:** If you have a USB flash drive connected to the DVR, you can format that, too. To do this, click the [USB Format] button and click [OK].

Note: It is an important first step when configuring your DVR to make sure that the hard drive (HDD) options are correctly set. So, strongly suggest that you do format the HDD before start the first record.

5.2.6.2 PTZ Set

Click [Main Menu→Device→PTZ] to enter into the below window shown as Picture 5-47.



Picture 5-47

You could select the channel you desire to control and set PTZ protocol (Pelco-D or Pelco-P), Baud Rate (1200, 2400, 4800, 9600), Data bit (8, 7, 6, 5), Stop bit (1, 2), Parity Check (None, Odd, Even, Mark, Space), Address Code and Cruise status respectively. Please note the PTZ device can be activated only when a channel in connection with the PTZ camera is selected.

5.2.6.3 Serial Set

Enter into the [Main menu→Device→Serial Set] interface shown as Picture 5-48.



Picture 5-48

When operate DVR via keyboard, it is required to set communication protocol.

- **Baud rate:** set baud rate of serial communication.
- **Data bit:** set data bit of serial communication.
- **Stop bit:** set stop bit.
- **Parity Check:** set parity check to <None> or other.

5.2.7 System

5.2.7.1 General

Click [Main Menu→System→General] to enter into the interface shown as Picture 5-49



Picture 5-49

You will be allowed to modify system date/time, date/time format, time zone, language, video format and menu time out.

And click [DST Setup] button to enter into the below interface shown as Picture 5-50, and you are allow to configure DST status and mode.

- Click [NTP setup] to enter into the interface shown as Picture 5-51 and now allow you enable/disable the NTP function.

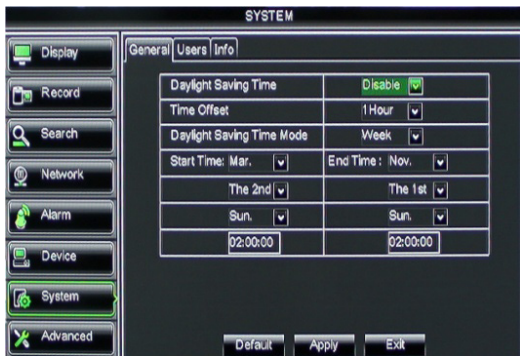

Picture 5-50

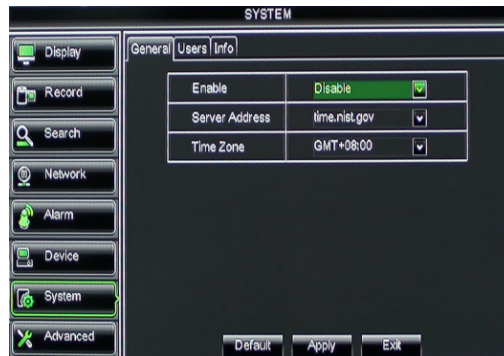

Picture 5-51

Note: The above [NTP function] change will be available only when system connected to internet. And When NTP function is set to “Enable”, system will calibrate the time at every 00:07:50 and every start-up.

5.2.7.2 Users

Click [Main Menu→System→Users] option and then enter into the interface shown as Picture 5-51

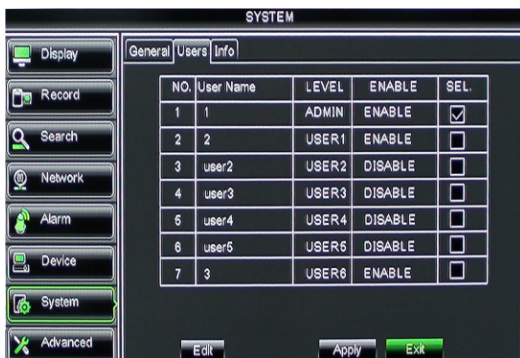

Picture 5-52

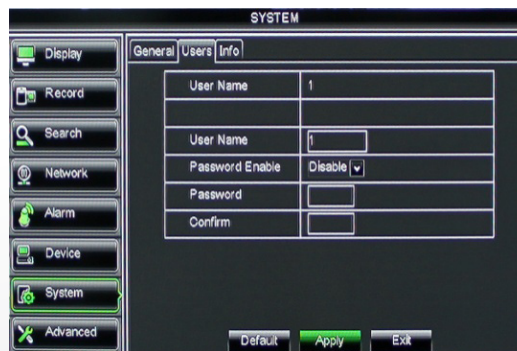

Picture 5-53

The model supports up to seven users with one Admin and six users. Click [Edit] button to enter into the [User Edit] interface shown as Picture 5-53. And input user name and password. Select one <common user> and click <Apply>, and then enter into <Authority set> interface shown as Picture 5-54. [Admin] is authorized to set common user's authority.

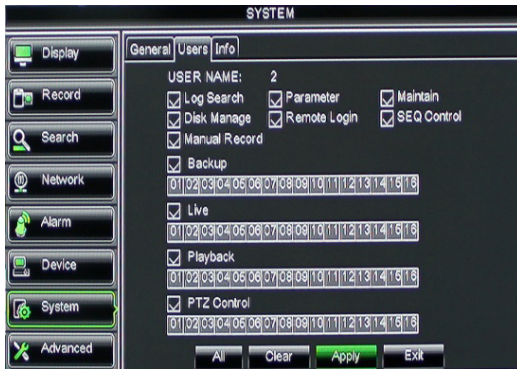

Picture 5-54

- **Log Search:** allow you check all the system logs.
- **Parameter:** allow you set all the parameters.
- **Maintain:** allow you update version, recover ex-factory value, device reboot and shut down.
- **Disk Manage:** allow you manage and control the HDDs.
- **Remote Login:** allow you remote login DVR.
- **Rotate Control:** allow you sequence live screens for all the channels.
- **Manual record:** allow you manually start/stop record.

- **Backup:** Tick-select the option, the user is allowed to backup the record of all the channels.
- **Live:** Tick-select the option and the user is allowed to view all the live images for all the channels.
- **Playback:** Tick-select the option and the user is allowed to playback the record you selected.
- **PTZ control:** Tick-select the option and the user is allowed to perform the PTZ operation for the selected channel.

5.2.7.3 Information

Click [Main Menu→System→Info] and then enter into the interface shown as Picture 5-55.



Picture 5-55

Now user can check the current Device name, Device ID, Device type, Device S/N, MAC address, IE version, Software version, Panel version etc.

5.2.8 Advanced

5.2.8.1 Maintain

Click [Main menu→Advanced→Maintain] to enter into the maintain interface shown as Picture 5-56.

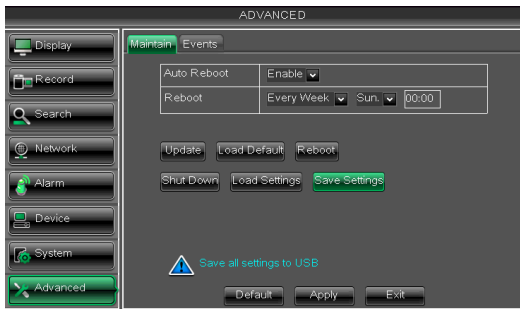

Picture 5-56

- **Auto Reboot:** You can enable the auto maintain function regularly as per user's need.
- **System Upgrade:** After decompressing update file package, copy the file named "dvrupgrade" to root directory of U flash disk; Insert the U flash disk into USB port of DVR; Click <Upgrade>.

- **Load Default:** If [Load Default] is selected, you can initialize the system to the ex-factory default.
- **Reboot:** Click [Reboot] button to manually restart DVR system.
- **Shutdown:** Click the [Shutdown] button to shutdown the device.
- **Load Setting:** Load the parameters in the U flash disk to device; after loading successfully, system will auto restart.
- **Save Setting:** Save the parameters of device to a flash disk.

Note:

1. Do not take out the USB memory or break the power during the update;
2. When the update is done, system will be automatically restarted;
3. Please manually recovery ex-factory default after system rebooting;
4. It will be available only when DVR return back to Preview mode and no any operation.

5.2.8.2 Event

Click [Main menu → Advanced → Event] to enter into the <Event> interface shown as Picture 5-58.



Picture 5-58

- **Event Type:** support the three abnormal types: Disk No Space, Disk Error and Video Loss.
 - **Enable:** allow you activate abnormal alarm.
 - **Alarm out:** select [Enable] or [Disable].
 - **Latch time:** you can set how long the buzzer will sound when external sensor alarm is detected (10s, 20, 40s, 60s).
- Show Message:** You can set show message on the screen when sensor alarm is detected.

5.3 Menu Lock

Considering a system safety feature you can click [] icon to lock system interface when leaving the DVR. If you want to login to the DVR again, you would input device code and password to unlock the interface shown as Picture 5-59.



Friendly Reminder: Administrator has full authority over Main Menu operations and has an authority to limit common user's operation.

Picture 5-59

5.4 Split mode

The model displays 4/8 live images in the sequence of single, 4-split and 9-split modes. If you enter into 4-split mode, the live images will be displayed in turn CH1~4, CH5~8... and CH13~16.

If you enter into 9-split mode, the live images will be displayed in turn CH1~9→CH10~16.

5.5 PTZ Control

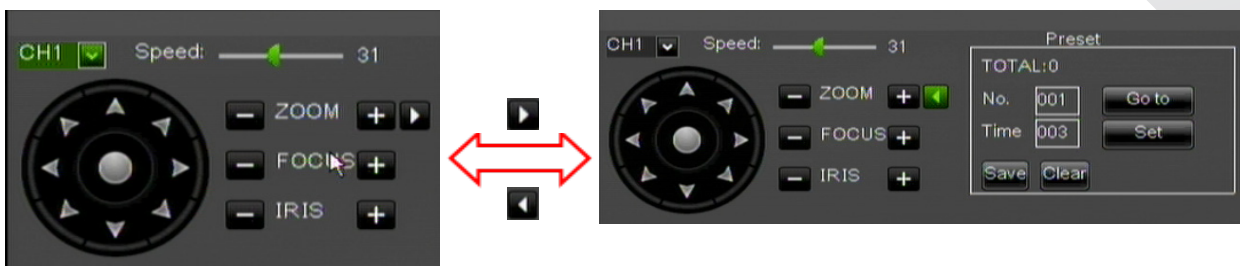

Picture 5-60

Click the [PTZ] icon to enter into [PTZ control] menu shown as Picture 5-60. Now user can control the camera with Pan, Tilt and Zoom capabilities.

Click [Zoom-/+] button to zoom in/out the image; Click [Focus -/+] button to focus the image; Click [Iris -/+] button adjust iris to open or close.

How to set pre-set point

- **Total:** set up pre-set point quantity
- **Cur Point:** indicates starting point cruised. System default point is 01. The model supports up to 255 pre-set points.
- **Stop time:** sets the stop time at each point and range is 1~255;
- **GOTO:** allow you go to a specific preset point.
- **Set:** allow you set a set of specific preset points of a PTZ camera.
 1. Select a camera you desire to set a preset point;
 2. Adjust the camera in a desired direction;
 3. Click [Set] to set the point as preset point;
 4. Click [Save] to save the preset point;
 5. Follow the above step to add one more preset point.
- **Save:** save all the preset points.
- **Clean:** allow you delete one selected preset point.

Note: Up to 254 pre-sets per one camera can be stored. However, actual preset quantity differs depending on PTZ performance.

5.6 PIP Mode

You can display a Picture-in-Picture in live mode. PIP has two display modes, including 1x1 display mode and 1x2 display mode.

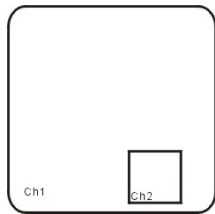

1x1 display mode

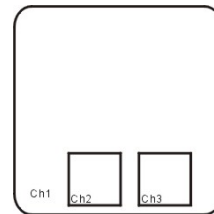

1x2 display mode

5.7 Record Search

You could enter into [Record Search] menu from Pop-up menu conveniently and quickly and search/playback the record histories. We introduced Record search details previously in section 5.2.3.1.

5.8 Mute

Click the  icon, or press <Mute> button on the front panel and Remote controller to control the mute of DVR.

5.9 Manual Record

You can start manual record function, or you also can click  button on the Front panel or Remote controller to activate manual record. Please stop record manually once you activate manual record.



5.10 Stop Record

To stop record quickly, please click the icon  or [Stop] button on the front panel or remote controller.

5.11 Start Sequence

In the single mode, when entering into [Start Sequence] menu, auto-sequence will be conducted at the set interval. Details please refer to section 5.3.1.2.

5.12 Start Cruise

If multiple presets are specified, the PTZ camera will automatically move to the entire preset one at a time whilst user activates [Start Cruise ] options. If you want to stop cruise, please click  icon on the [Tool] column.

Chapter 6: Web Application Manager

6.1 ActiveX control download and installation

Open your web browser and input the IP address and web port of DVR, such as: <http://172.18.6.202:8080/>. If your computer is connected to internet, it will download and install "ActiveX" Plug-in automatically. If your computer system is Vista, you may need to setup the user authority. Details please refer to the below picture: Start→Setup→Control panel (Tick "√" use UAC to help protect your computer and confirm OK).

Vista System

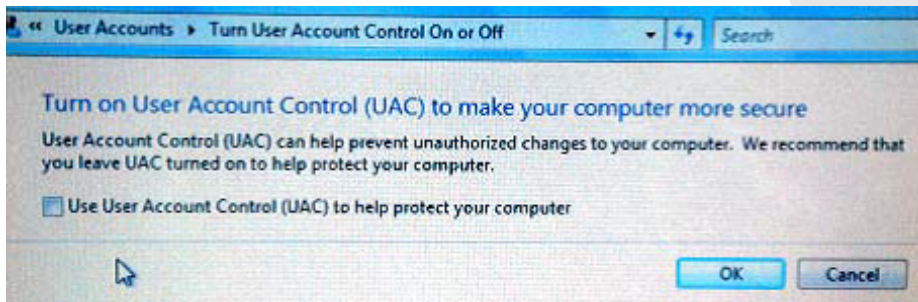

Vista

Win-7 system.

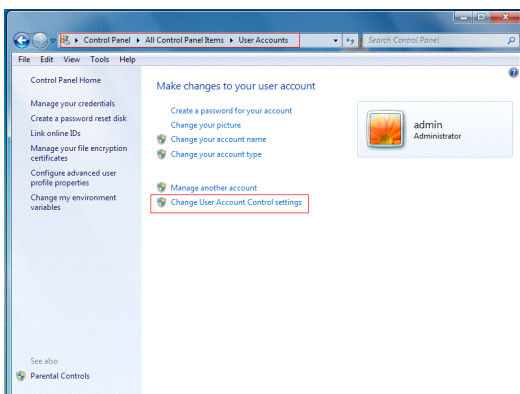

WIN7-1

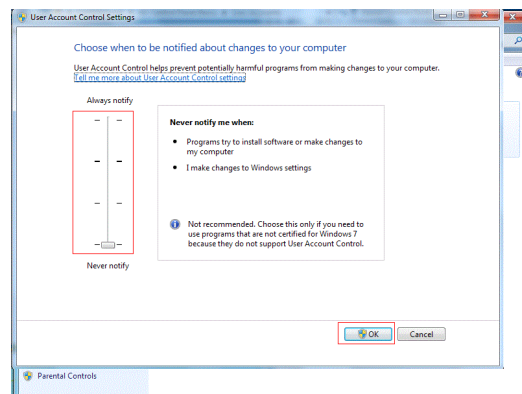

WIN7-2

Reminder: If the ActiveX control is not downloaded successfully, please check if your browser's safety level or firewall setting is too advanced. Please run IE→Tools→Internet options→Internet Custom level→Enable the options (details please refer to the below Picture 6-1).

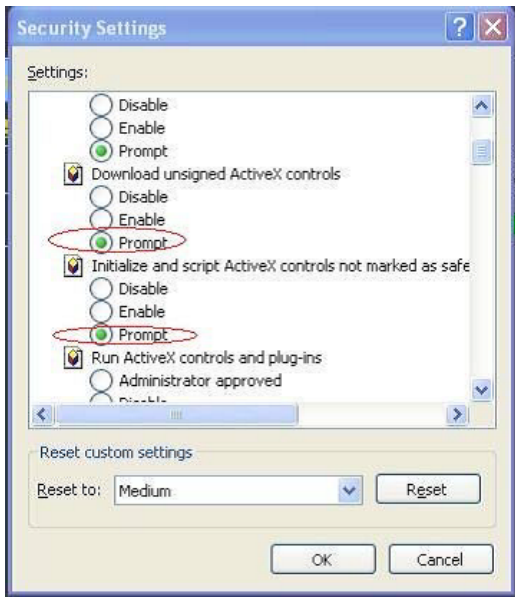

Picture 6-1

If running the web application for the first time, you need about one minute to finish download and install the ActiveX controls, please wait patiently.

Note: If you want to use the undated webcam at one computer which you already login before, please delete the old IE webcam and click [Start→Run] and then input the command characters: "regsvr32/u HiDvrOcx.ocx", then login again.

6.2 Web Application Manager Log-in

After ActiveX controls installation, please input user name, password and client port; and select <Main stream> or <Sub stream>, and then allow you tick-select <Open All Channels Preview>;

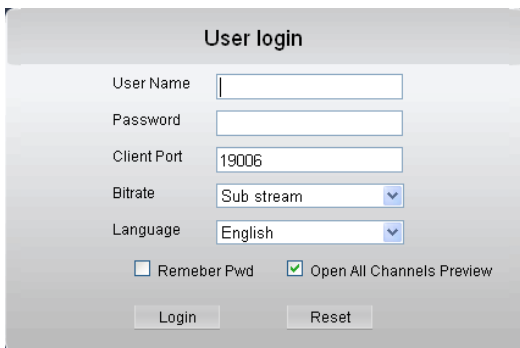

Picture 6-2

Now you click [Log-in] button, and then you are allowed to access a remote DVR and monitor live video images using Web browser anytime from virtually anywhere.

Noted that defaulted password is empty. System allows Administrator to set new password as per instructions in section 6.3.3.6 - [System→User Configuration] menu.

6.3 Live interface

After successful logging-in web manager, you will enter into the Live interface shown as Picture 6-3





Picture 6-3

6.3.1 Menu Bar

Menu bar include [Live], [Replay], [Configuration], [Path Configuration] and [Logout] options







6.3.1.1 Live Display

After running the Web Application Manager on your local PC, system will be defaulted to enter into <Live> interface shown as Picture 6-3. You can click [Play] button to Open/close live images and enter into on-spot record and Capture, quad, 9-split or 16-split mode by operating the control bar on the bottom of screen.

- : Volume switch
- : Record icon: record will be saved to a specified position after starting record.
- : Snapshot function: allow you capture the live images and save it to a specified position. The image should be saved as *.bmp format.

: Clicking the icon will close/open the current channel's live mode
Or click the right key of mouse on each <Live> window to pop up the interface shown as Picture 6-4.

Show bit rate: Right-click the Preview window and tick-select the option to show current bit rate;

- : Allow you open all the <live> channels
- : Allow you close all the <live> channels.
- : Display previous group of channels
- : Display next group of channels
- : Click the icon to enlarge current window to full screen; right-click to pop-up menu options, now allow you select <Exit full screen>
- : Toggle between original proportions and Adaptive Screen Resolution.

: CH Split mode

6.3.1.2 PTZ Control

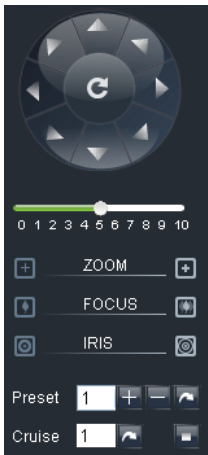

Picture 6-5

① PTZ moving Direction control: allow you control PTZ camera's direction. And the middle button is called [Auto-cruise] button.

②  : PTZ speed control bar

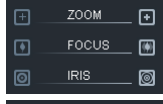
③  : Iris, Focus and Zoom control

④  : Preset setting/clear; Start cruise/stop cruise

6.3.1.3 Video control

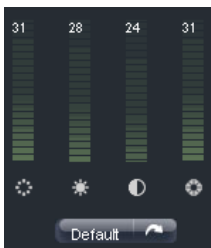



Picture 6-6

 : Adjust video Hue

 : Adjust video brightness

 : Adjust video Contrast

 : Adjust video saturation

 : Recover ex-factory default value

6.3.2 Playback

Click [] icon to enter into <Playback> interface shown Picture 6-7.

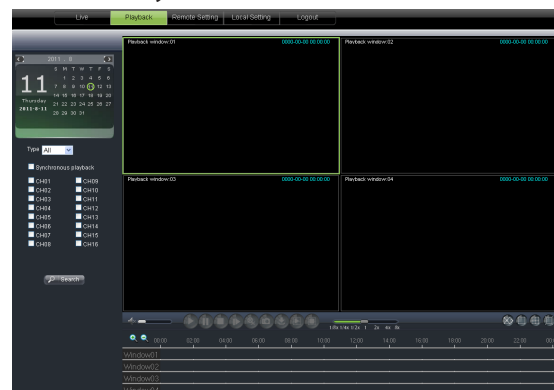

Picture 6-7

6.3.2.1 Record search

Firstly, select one day you want to check and tick-select <Synchronous playback> and the channels you desire to playback shown as Picture 6-8.

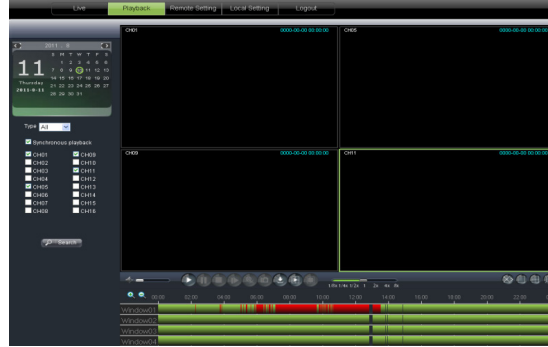

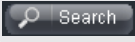

Picture 6-8

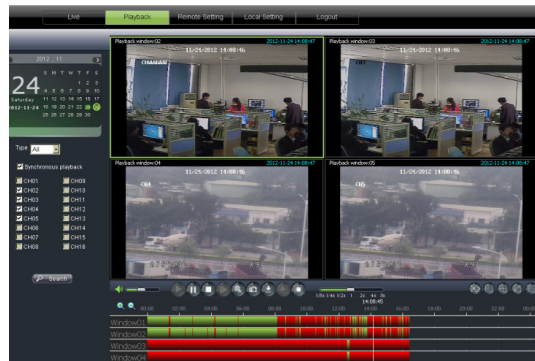
Secondly, select record type (Normal record, Alarm record and All) and then click <  Search > button shown as Picture 6-9. On the time axis, red part stand for alarm record, yellow stand for normal record and original part stand for no record during this period.

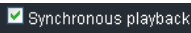

Picture 6-9

If you tick-select <  Synchronous playback > option, that means the selected channel will playback synchronously; otherwise, you could separately control the channels playback. Thirdly, click  icon to start record playback. When mouse cursor is moving on the time axis, the current time will appear in the screen. Click  icon to zoom in/out the time bar display ratio shown as Picture 6-9.





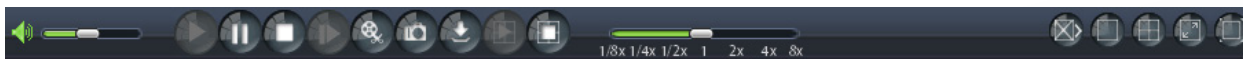







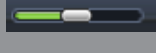

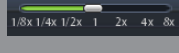

6.3.2.2 Playback control

Below Picture 6-10 is playback control bar



Picture 6-10

Detail brief description is shown as below list

Key	Description	Key	Description
	Play		Open/close audio
	Pause		Volume adjust
	Stop		Playback control bar (x1/2, 1/4, 1/8, normal, x2, x4, x8)
	By frame		Stop all the play
	Clip		Single channel mode
	Snapshot		Quad mode
	Download		Full screen
	Open all the channels		Toggle between original proportions and Adaptive Screen Resolution.
	Stop all the channels		

Record file clip

After opening playback, click [] icon to clip the selected file; and click again to stop the clip function. Record clip file will be saved as *.264 format.

Snapshot function

Move the mouse cursor to the channel you want to capture, and click [] icon to capture the live images remotely. After capturing the images successfully, you are allowed to save it to a specified path shown as Picture 6-11. The captured file will be saved as *.bmp format.

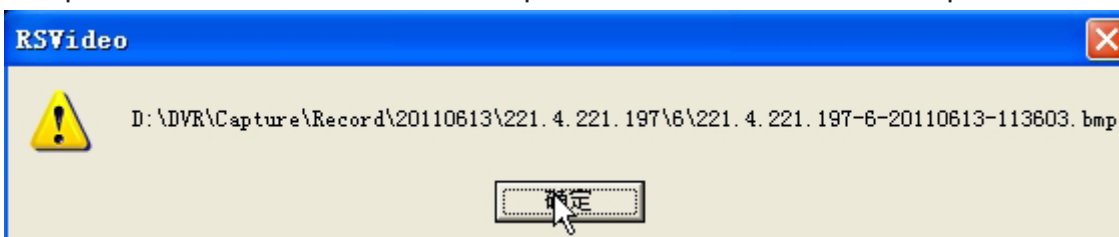

Picture 6-11

Record file download

Click [] icon to enter into the below interface shown as Picture 6-12.

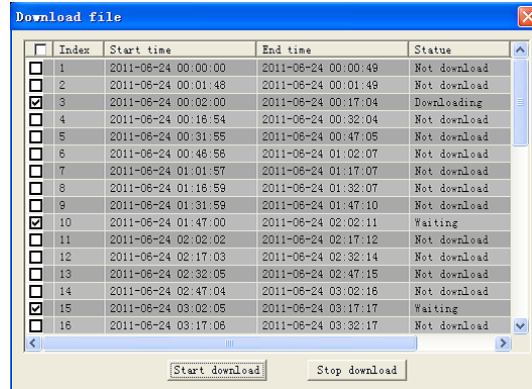

Picture 6-12

Tick-select the record file you want to download and click [Start download]. System will download the record file in turn and save to local PC.

6.3.3 Configuration

6.3.3.1 Display Configuration

Unfold [Display] option to find its sub-options: Live and Privacy zone

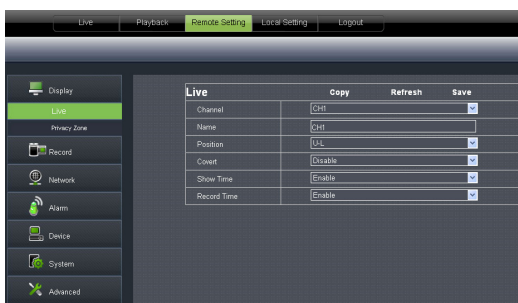

Picture 6-13

1. **Live:** Allow you modify channel name, Position, Show time and Record time. If show time is set to <disable>, current system time will not appear on the screen on Live mode; and if record time is set to <off>, system time can't be found in the record file.

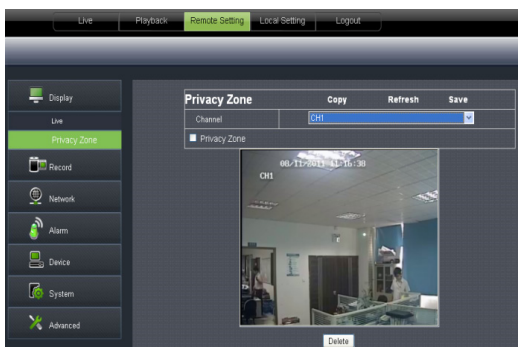

Picture 6-14

2. **Privacy zone:** Each channel could set up to four privacy zones shown as Picture 6-14. Details parameters please refer to section 5.2.1.3. If you want to delete one privacy zone, please firstly select one zone, and then click <Clear> button and click <Save> on the right corner

6.3.3.2 Record

Click <Record> option to unfold its sub-options: Record parameter, Schedule and Main stream.



Picture 6-15

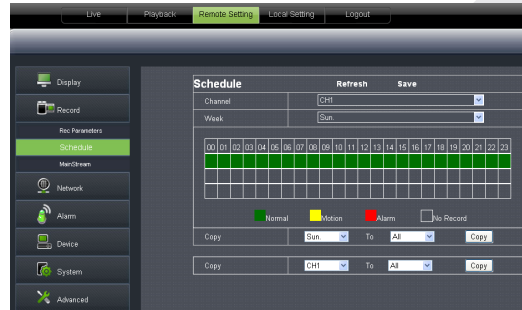

Picture 6-16



Picture 6-17

1. **Record Parameters:** Under [Record parameters] option, allow you set channel, record enable, pack time and Pre-record status shown as Picture 6-15;
2. **Schedule:** Detailed parameters please refer to DVR local setting (shown as Picture 6-16). Green stand for Normal record; Yellow stands for Motion detection; Red stands for I/O triggered record.
3. **Main Stream:** detailed settings please refer to DVR local setting (shown as Picture 6-17). Herein allow user modifies the resolution, frame rate, Bit rate and audio of the record channel.

6.3.3.3 Network Parameters

Unfold <Network> option to enter into its sub-options: Network, sub stream, Email, mobile and DDNS configuration.

1. Network



Picture 6-18

The model support three network type, including Static, DHCP and PPPoE. System default <Static> as its network type. User could allocate IP and perform Port forwarding for DVR according to different router. When set <UPNP> to "On", user no needs to perform port forwarding. Once you modify the network parameters successfully, will automatically restart. DVR

For details parameters please refer to Picture 6-18, Picture 6-19 and Picture 6-20.



Picture 6-19



Picture 6-20

2. **Sub stream** (shown as Picture 6-21): Relative parameters should be consistent with DVR local setting.

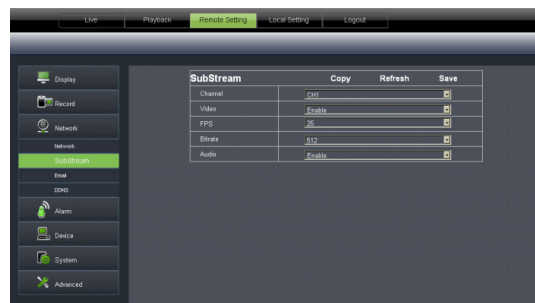

Picture 6-21

3. **Email setting:** Click [Email setting] option to allow you set alarm email configuration parameters shown as Picture 6-22. Detailed parameters should be consistent with DVR local setting.

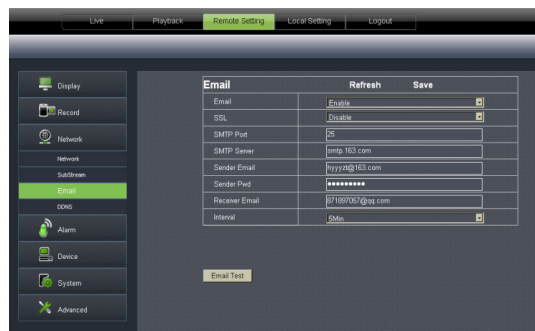

Picture 6-22

4. DDNS Setting

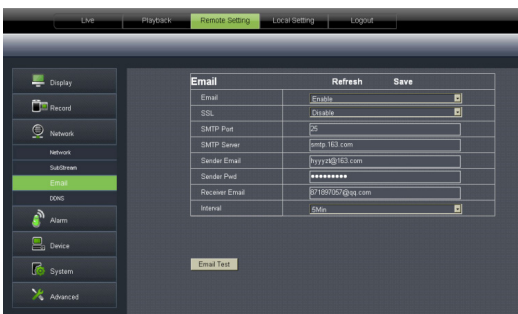

Picture 6-23

After user applies for DDNS service shown as Picture 6-23, you could enable <DDNS> function under any one network type mode (Static, DHCP and PPPoE). Now you remotely visit the DVR through domain name (<http://domain name: port No>). Details setting should be consistent with DVR local setting.

6.3.3.4 Alarm Set

Click <Alarm> option to unfold its sub-options: Motion, I/O Alarm shown as Picture 6-24.

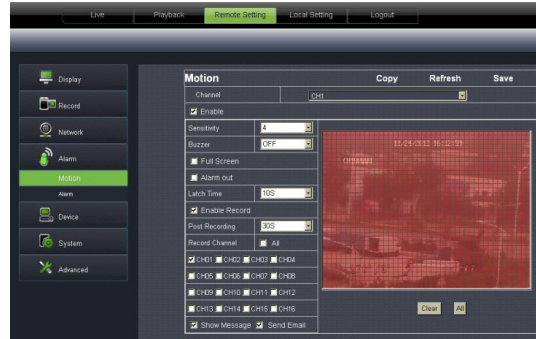

Picture 6-24

1. **Motion Detection:** allow you configure its <Sensitivity>, <Alarm out>, <Alarm record> and <Alarm Capture> etc.. Details setting should be consistent with DVR local setting (Shown as Picture 6-25).

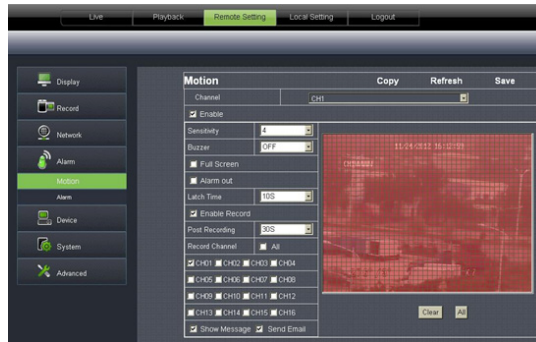

Picture 6-25

2. **I/O Alarm:** allow you configure <I/O Status>, <Alarm output>, <I/O Alarm record> and <Alarm email> etc.. Details setting should be consistent with DVR local setting (Shown as Picture 6-26).



Picture 6-26

6.3.3.5 Device

Click <Device> to unfold its sub-options: HDD and PTZ.

1. **HDD:** Allow you check out HDD status and overwritten time shown as Picture 6-27. Detail setting should be consistent with DVR local setting.



Picture 6-27

2. **PTZ:** Configuration (shown as Picture 6-28): Details setting should be consistent with DVR local setting.



Picture 6-28

6.3.3.6 System

Click <System> option to unfold its sub-options: General, Users and information.

1. **General:** User could check DVR's language and video system, and also set system time, date format, DST and NTP shown as Picture 6-29. Details setting should be consistent with DVR local setting.

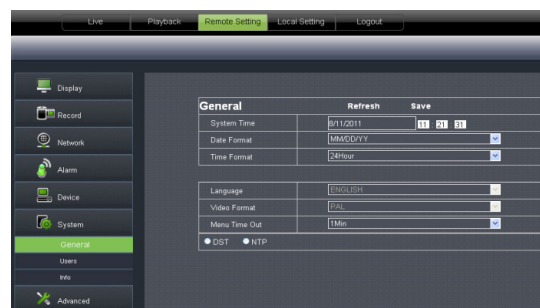

Picture 6-29

2. **Users:** Allow you configure user name and password shown as Picture 6-30. Details setting should be consistent with DVR local setting.



Picture 6-30

3. **Information:** Allow you check out device name, number, type, MAC address, software version, IE version and hardware version shown as Picture 6-31.



Picture 6-31

6.3.3.7 Advanced

1. Click <Advance> to unfold its sub-options: System update, Load default, Events and system maintain etc..
System update: allow you upgrade DVR system remotely shown as Picture 6-32.

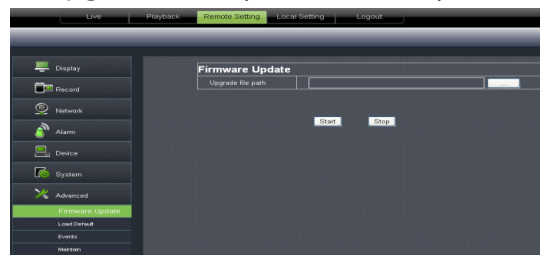

Picture 6-32

Please follow below steps to upgrade the system:

- a. Select the upgrade file's path shown as Picture 6-33. Please note that the format of upgrade file is *.sw.

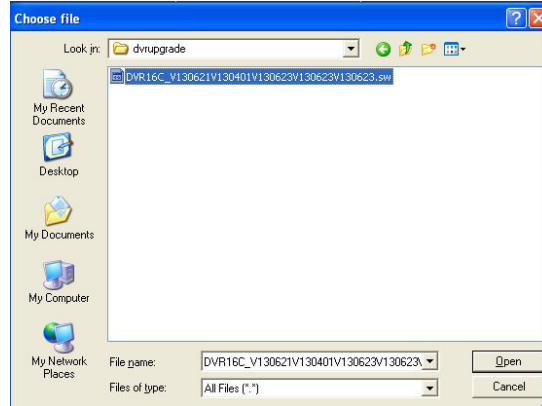

Picture 6-33

- b. Click <Start update>, now processing bar will display current upgrade status shown as Picture 6-34.

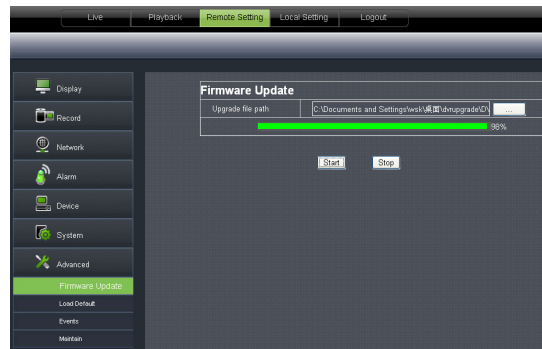

Picture 6-34

2. **Load Default:** allow you recover defaulted parameters of DVR remotely shown as Picture 6-35. Details setting should be consistent with DVR local setting.

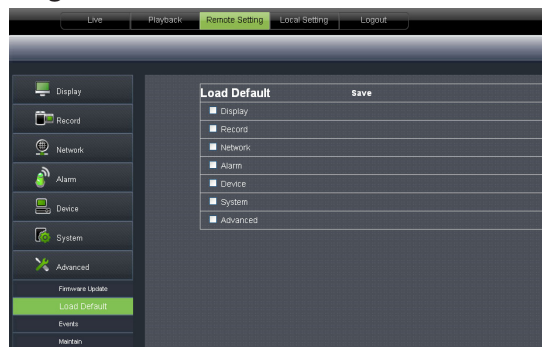

Picture 6-35

- Events:** Allow you configure abnormal type, buzzer output time, and alarm email and show message shown as Picture 6-36. Details setting should be consistent with DVR local setting.

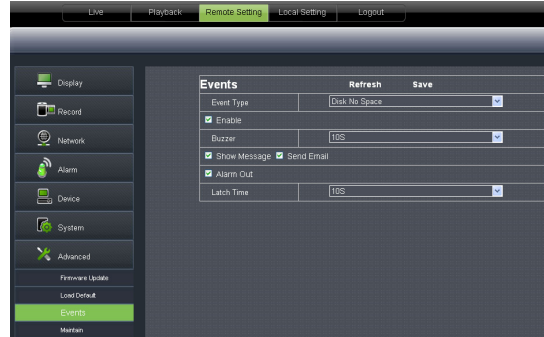

Picture 6-36

- Maintain:** Allow you set auto system maintain for DVR remotely shown as Picture 6-37. Detail setting should be consistent with DVR local setting.

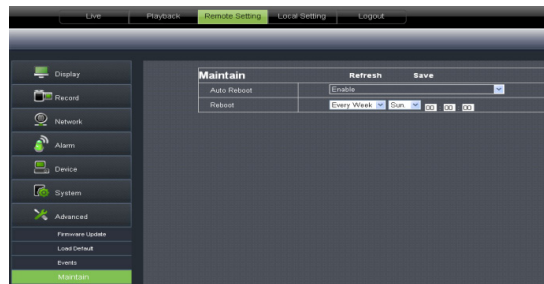

Picture 6-37

6.3.4 Local setting

Under <Local setting> option, user could set record path of record file (Live record and Playback clip file), download path of remote file, Snapshot path, File type (H.264 and AVI) and Internal shown as Picture 6-38.



Picture 6-38

6.3.5 Logout

Click the [Logout] icon to return back the log-in interface.

Chapter 7: Appendix
7.1 Operation Function Table

Type	Title	Description
Basic setting	Time setting	Set system date/time, display format and day-light saving time.
	Language select	Set system language.
	Channel setting	Set CH title and position; adjust image color parameter value; set CH display to ON/Off and time display/recording time overlaying to On/Off.
	Record setting	Set image quality, resolution, volume, record mode and pack time.
	Record search	Time based search, channel based search and rec. mode based search.
	Record Playback	Specified time playback, scheduled playback, file list playback.
	Playback mode	Play, play frame by frame, multi-speed forward and multi-speed rewind.
	File backup	U flash disk and removable HDD backup, DVD recorder backup and network download .
	HDD Manage	Check HDD status, usage space, setting HDD auto-overwrite.
	VID/AUD Setting	Adjust VGA resolution, select system and volume control, set interval and channel display.
Advanced Setting	User password	Set or modify user password.
	Alarm setting	Set HDD loss, HDD space, video loss, I/O status, alarm management and Email alarm.
	Motion detection	Set on/off status of MD; select sensitivity and set motion detection area.
	PTZ setting	Select CH and set PTZ protocol, baud rate and PTZ address for the CH.
	Mobile surveillance	Set user name, password and server port.
	System maintenance	Set system auto maintenance, maintenance time regularly, system upgrade, ex-factory default value recovery and manual restart system.
	Display mode	PIP display, Zoom in/out, split mode, auto sequence and cruise display.
Network setting	Network and Port setting	Select network mode and set net-viewer port, web port, DNS and DDNS parameters.

Type	Title	Description	
Network Function	Live display	Rea-time video surveillance remotely.	
	Remote record	Set record mode and status of DVR remotely.	
	Remote playback	Check local record history via network.	
	PTZ control	Remotely control PTZ camera, position, focus, zoom and iris etc.	
	parameter set of DVR remotely	Set local CH display, record, alarm, PTZ control parameter value via network.	
	Network download	Backup record file via network.	
Auxiliary function	System info	Check device ID, software version and MAC address.	
	()	In addition to illustrating picture, Parenthesis generally indicate optional parameter value of previous menu.	
Menu button	Enter	Clicking the button will save current parameter.	
	Default Recovery	Clicking the button will recover current parameters to system defaulted value.	The option will be effective after clicking [Enter] button.
	ESC	Clicking the button will exit the current menu.	
Basic application Guide	Time setting	Adjust system time.	
	HDD Manage	Format HDD.	The option will be effective after restart.
	Net setting	Set network type and web port (except of PPPoE, other type need forward web port to router of DVR.	The option will be effective after restart.
	System Info	Modify MAC address.	
	Mobile Monitoring	Set relative parameter.	
	Other	PTZ setting, Record set and Language select etc.	

list: 8-1

7.2 Record Alarm setting

Under the record mode, [R] icon or [M] icon will appear on the screen, and alarm will be issued. You have configured record type to <Normal> on the <Scheduled> mode, once one alarm occurred, the record will be saved as Normal record, on the contrary, configured to <Alarm>, once one alarm occurred, the record saved as Alarm record.

Under the Scheduled mode, no-record interval allow you activate manual record and the record file can be saved as Normal record.

7.3 Mail box server List

Web site	Mail box	Sender server (25)	Receiver server (110)
www.163.com	@163.com	smtp.163.com	pop3.163.com
	@vip.163.com	smtp.vip.163.com	pop.vip.163.com
	@188.com	smtp.188.com	pop.188.com
	@126.com	smtp.126.com	pop3.126.com
	@netease.com	smtp.netease.com	pop.netease.com
	@yeah.net	smtp.yeah.net	pop.netease.com
www.qq.com	@qq.com	smtp.qq.com	pop.qq.com
163.net		smtp.163vip.net	popx.163vip.net
www.sina.com	@sina.com.cn	smtp.sina.com.cn	pop3.sina.com.cn
www.yahoo.com	@yahoo.com.cn	smtp.mail.yahoo.com.cn	pop.mail.yahoo.com.cn
	@yahoo.com	smtp.mail.yahoo.com	pop.mail.yahoo.com
google.com	@gmail.com	smtp.gmail.com(465/587)	pop.gmail.com(995)
www.china.com	@china.com	smtp.china.com	pop.china.com
www.sohu.com	@sohu.com	smtp.sohu.com	pop.sohu.com
Mail.163.com		smtp.163.net	pop.163.net
Mail.163vip.com		smtp.163vip.net	pop.163vip.net
Mail.tom.com	@tom.com	smtp.tom.com	pop.tom.com
Mail.263.com	@263.net	smtp.263.net	pop3.263.net
x263.net		smtp.x263.net	pop.x263.net
263.net.cn		smtp.263.net.cn	pop.263.net.cn
139 mail box	@139.com	smtp.139.com	pop.139.com
21cn.com		smtp.21cn.com	pop.21cn.com
Vip.21cn.com		vip.21cn.com	vip.21cn.com
etang.com		smtp.etang.com	pop.etang.com
elong.com		smtp.elong.com	pop3.elong.com

List 8-2

7.4 Troubleshooting

1. Q: What can I do if the system does not detect the HDD?
A: Check if the power supply system is properly connected and data cord and power cables are securely connected.
2. Q: We have changed the password but do not remember the new password, how can we access the system?
A: If you forget system password, please consult with the service personnel.
3. Q: We are not getting any video signal on the DVR, what is wrong?
A: Check camera video cable and connections; or check monitor video cable and connections; or confirm that the camera has the power and/or check camera lens setting.
4. Q: Why some channels display just a blank screen even if they receive video sources?
A: Check if the camera is connected to the system properly displays the image; check if the camera is properly supplied with power.
5. Q: Can the DVR have problems if it gets too hot, how can I prevent this?
A: The DVR has a fan to help it dissipate heat while it is running. Please place the DVR in a place where there is good air circulation and away from heat sources to increase stability and life of the DVR.
6. Q: "Record" Can not work normally, how to deal with?
A: Check if the current screen is in Play mode, pressing [Stop] button to exit the Play mode and then you can enter into the [Record] function.
7. Q: Why the Remote Controller can't work normally?
A: Check if the battery is power off; or check if the Remote Controller is broken.
8. Q: Can we records whilst playing-back?
A: Yeah, you can do it. The system support you records whilst playing-back.
9. Q: Can we erase some recorded file from DVR.
A: Considering the safety factor, you can't delete the recorded file directly from the device. When you actually erase all the recorded files, please select HDD format function
10. Q: Why does the Buzzer keep sounding?
A: Please check if motion detection is on and the system has detected motion, make sure the HDD is being detected and has sufficient space available; check if video has lost etc.
11. Q: Why can't stop [Stop] function?
A: Pressing [Stop] button only can stop manual record. If you want to stop Scheduled record, please revise to [No Record] during this period.

7.5 Usage Maintenance

1. Please close the [OFF] button on the front panel firstly to avoid any data missing.
2. Please make sure DVR keep away from heating source.
3. Clean the internal dust regularly, keep DVR aeration well and be easy to heat dissipate.
4. Please not plug in RS-232 and RS-485 when power is on to avoid any damage to the port.
5. Please check the HDD cable and data cable to avoid the cable aging.
6. Please avoid other electronics device interfere video/audio signal of DVR a.s.a.p., or static electricity and induced voltage damage to DVR.
7. Suggest user replace BNC cable regularly to keep signal input stable.

7.6 System Connection Diagram

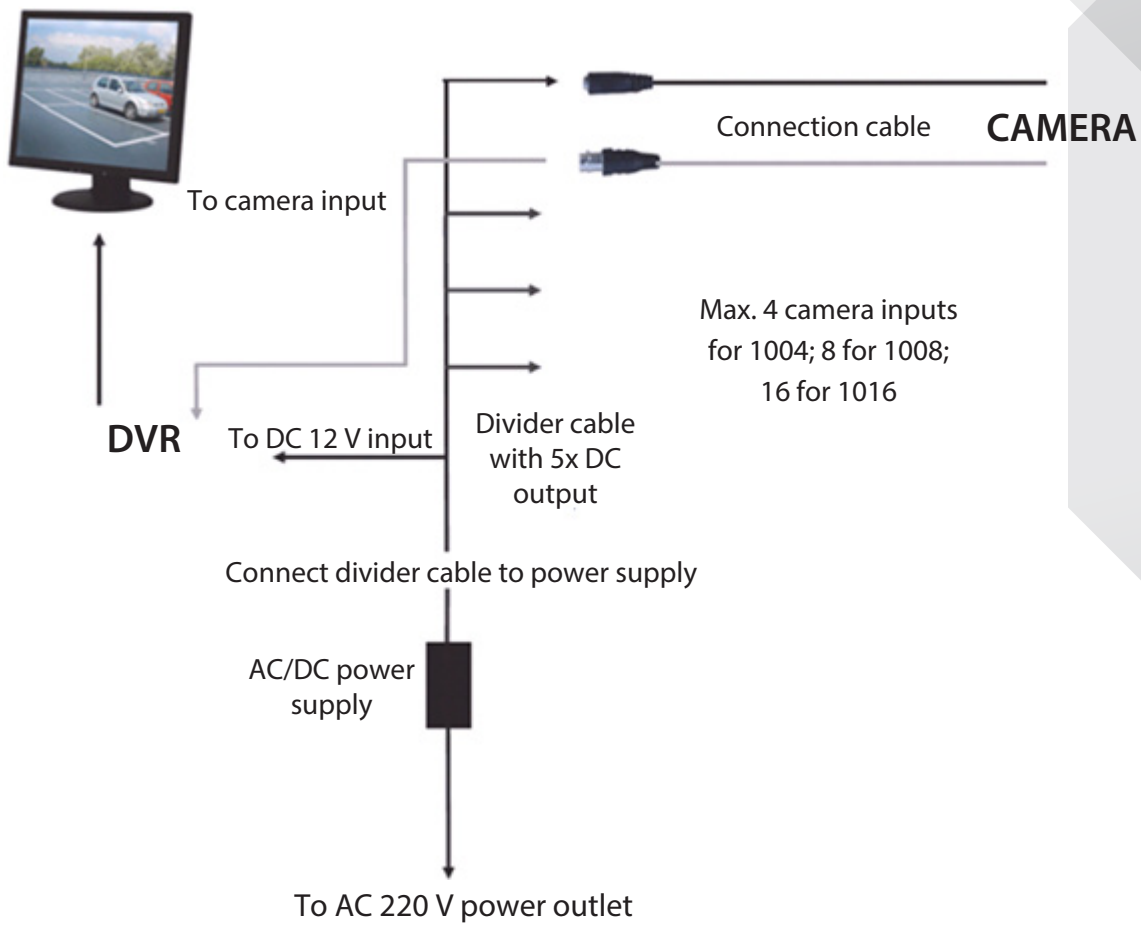

Chapter 8: Cameras SAS-CAM1100/1110, 1200/1210

Specifications:

- Image chip: 1/4" CMOS
- Lens: 3.60 mm
- Horizontal resolution: 700 TVL
- View angle: 45°
- Infrared LED: 24 pcs, 5~10 M
- Light sensitivity: 1.5 lux
- Electronic shutter: 1/50(1/60)~1/100,000 sec.
- S/N ratio: > 48 dB
- Gain: auto
- Gamma correction: > 0.45
- Protection: IP66
- Working temperature: -20 °C~55 °C
- Video out: 1.0 V p-p/75 Ω
- Voltage: DC 12 V
- Dimensions: 145x60x55mm
- Weight (with bracket): 350 g

Product description:

1. Camera lens
2. Light intensity sensor
3. IR LED
4. BNC connector for video
5. DC connector for 12 V

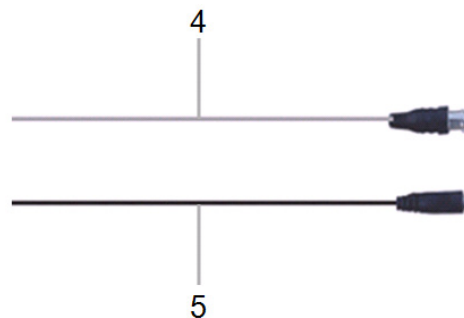

Specifications:

- Image chip: 1/4" CMOS
- Lens: 3.60 mm
- Horizontal resolution: 700 TVL
- View angle: 45°
- Infrared LED: 24 pcs, 5~10M

- Light sensitivity: 1.5 lux
- Electronic shutter: 1/50(1/60)~1/100,000 sec.
- S/N ratio: > 48 dB
- Gain: auto
- Gamma correction: > 0.45
- Protection: IP66
- Working temperature: -20 °C~55 °C
- Video out: 1.0 V p-p/75 Ω
- Voltage: DC 12 V
- Dimensions: 100x75 mm
- Weight (with bracket): 250 g

Product description:

1. Camera lens
2. IR LED for night vision
3. Light intensity sensor
4. BNC connector for video
5. DC connector for 12 V

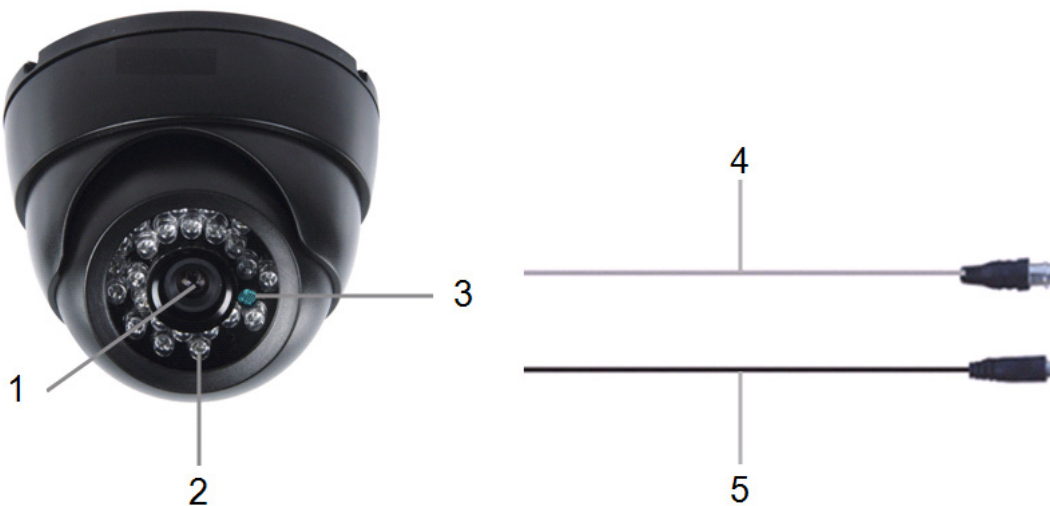

Chapter 9: Mobile device support



This DVR supports live feed from the cameras to your mobile device, such as smart phone and/or tablet. So that you can have “on the go” access to your security system from virtually anywhere. To view, you must install the RXCamPro App into your mobile device. The Apps are located in the stores of Apple (iOS 5.0 or above) and Google Play (Android 2.3 or above)

Note: for using the mobile device support, the DVR must be connected to Internet with the correct network settings.

Chapter 10: General information

Warranty:

Any changes and/or modifications to the product will void the warranty. We cannot accept any liability for damage caused by incorrect use of this product.

Disclaimer:

Designs and specifications are subject to change without notice. All logos, brands and product names are trademarks or registered trademarks of their respective holders and are hereby recognized as such.

Disposal:

- This product is designated for separate collection at an appropriate collection point. Do not dispose of this product with household waste.
- For more information, contact the retailer or the local authority responsible for waste management.

This product has been manufactured and supplied in compliance with all relevant regulations and directives, valid for all member states of the European Union. It also complies to all applicable specifications and regulations in the country of sales. Formal documentation is available upon request. This includes, but is not limited to: Declaration of Conformity (and product identity), Material Safety Data Sheet, product test report.

Please contact our customer service desk for support:

via website: <http://www.nedis.com/en-us/contact/contact-form.htm>

via e-mail: service@nedis.com

via telephone: +31 (0)73-5993965 (during office hours)

NEDIS B.V., De Tweeling 28, 5215 MC 's-Hertogenbosch, THE NETHERLANDS